



2N Clip 2wire-IP

User Manual

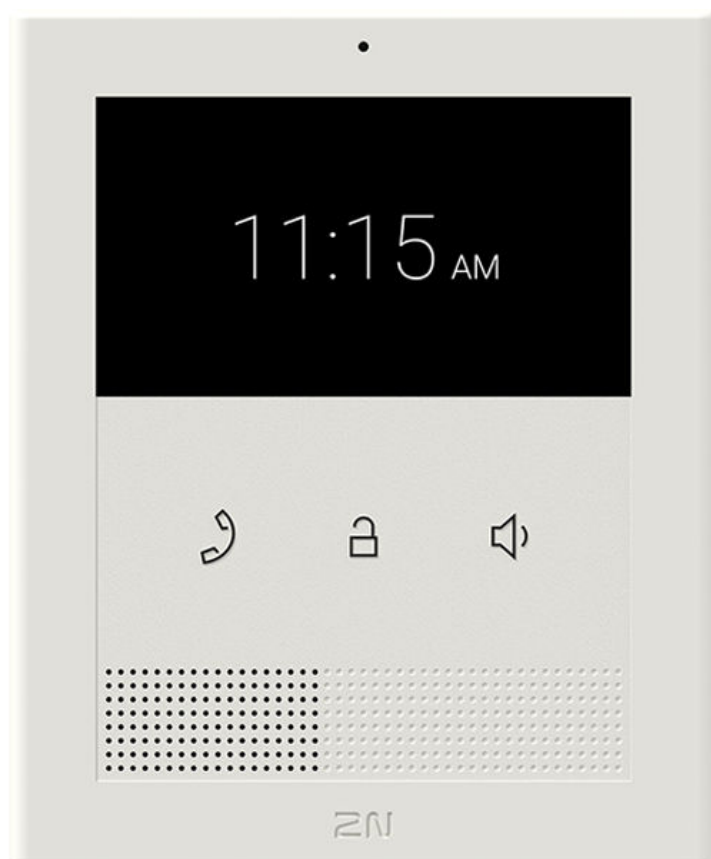

Table of Contents

Symbols and Terms Used	4
Product Description	5
Basic Features	5
Product Versions	6
Switches	7
Power Supply	7
Accessories for Installation	7
Package Completeness Check	7
Component Layout	8
Front	8
Rear	8
Switch controls and LED	9
Mechanical Installation	12
Installation Conditions	12
Switch Installation	12
LAN Connection	14
2N IP Intercom Connection	14
Floor Interconnection	14
Wall Installation	16
Single-Gang Box Mounting	18
Stand Installation	19
Device Removal	22
Power Supply	22
Tactile stickers	23
Brief Guidelines	24
IP Address Retrieval	24
IP Address Retrieval Using 2N IP Utility	24
IP Address Retrieval using Device Display	25
IP Address Retrieval Using the RESET button	25
Access to web device configuration	26
Password Change	26
Recommended browsers	27
Firmware Update	27
Device Restart	28
Restart Using Web Configuration Interface	28
Restart Using Device Buttons	28
Restart Using RESET Button	28
Factory Default Reset	28
Factory Default Reset via Web Configuration Interface	28
Factory Default Reset with RESET Button	29
Configuration via Hardware	29
Device Restart	29
IP Address Retrieval Using the RESET button	29
Static IP Address Setting with RESET Button	30
Dynamic IP Address Setting via RESET	31
Factory Default Reset with RESET Button	31
Web configuration interface	32
First Login	32
Finding devices in the network	32
Access to web device configuration	36
Basic Device Settings	37
Firmware Update	37
Directory	38

Calling	38
Display Settings	41
Advanced Settings	41
Sound Settings	41
Time Profiles	42
Advanced SIP Account Settings	42
System	44
Date and Time Settings	44
Network Configuration	44
Used Ports	45
Device Control	47
Button Functions	47
Home Screen	48
Directory Menu	49
Settings Menu	50
Ringtone Setting Menu	52
Operational Statuses	52
Signaling of Operational Statuses	52
Calls	53
Idle Mode	55
Device Lock	56
Maintenance - Cleaning	57
Troubleshooting	58
Technical Parameters	59
2N Clip 2wire-IP	59
2N Clip 2wire-IP Switch	61
General Instructions and Cautions	63
Directives, Laws and Regulations	63
EU	63
Industry Canada	64
Electric Waste and Used Battery Pack Handling	64

Symbols and Terms Used

The following symbols and pictograms are used in the manual:



DANGER

Always abide by this information to prevent persons from injury.



WARNING

Always abide by this information to prevent damage to the device.



CAUTION

Important information for system functionality.



TIP

Useful information for quick and efficient functionality.



NOTE

Routines or advice for efficient use of the device.

Product Description

In this section, we introduce the **2N Clip 2wire-IP** product, outline its application options and highlight the advantages following from its use.

Basic Features

2N Clip 2wire-IP is an internal IP/SIP unit providing communication with the 2N IP intercoms.

The device includes a control panel with three buttons, a loudspeaker, a high-quality microphone for excellent audibility and clarity, a 2-wire interface for connecting to the LAN, a power connector and a doorbell connector.

The device includes a control panel with three buttons, a loudspeaker, a high-quality microphone for excellent audibility and clarity, for connecting to the LAN, and connectors for connecting an external power supply and a doorbell connector.

2N Clip 2wire-IP is equipped with a specific user interface for an increased user comfort while configuring the device.

Basic Features **2N Clip 2wire-IP**:

- 2 mm thick plexiglass display
- LAN connection and power supply via a twisted pair cable
- remote administration and configuration via **2N Remote Configuration**
- device lock
- remote door lock control
- time display
- integrated administrator web interface
- integrated induction loop version option,
- external doorbell button input.

Complex solution connection diagram

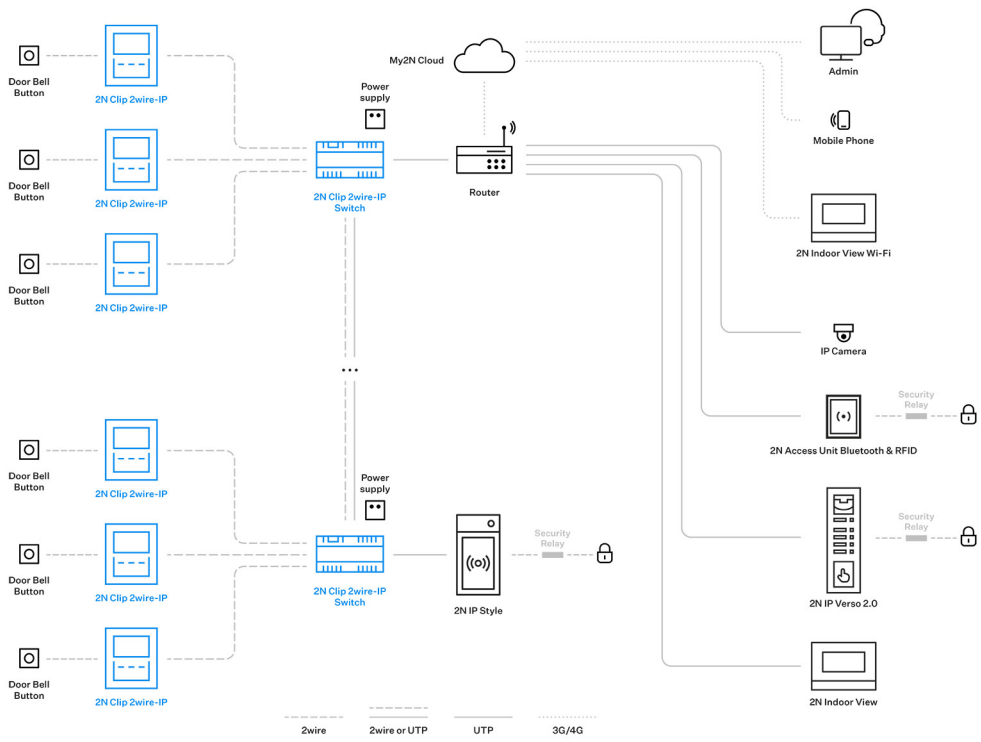

Product Versions

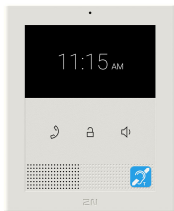

Part No.: 9138522
 Axis Part No. 03449-001
2N Clip 2wire-IP
 Version with induction loop

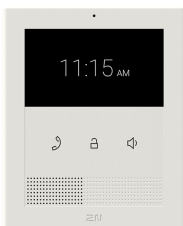

Part No.: 9138521
 Axis Part No. 03448-001
2N Clip 2wire-IP
 Version without induction loop

Switches

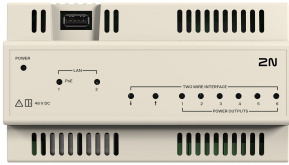

Order number: 9138001

Axis Part No. 03450-001

2N Clip 2wire-IP Switch

Switch with 2-wire interface for connecting up to 6 2N Clip 2Wire-IP units.

Power Supply



Part No. 1120302

Axis Part No. 03479-001

Power Supply for 2N Clip 2Wire-IP Switch

Accessories for Installation

Choose the proper accessories for your particular installation needs.

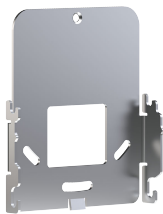

Part No. 9138003

Axis Part No. 02906-001

Mounting holder

Single-Gang Box installation plate for **2N Clip 2wire-IP**.

US mounting metal holder for **2N Clip 2wire-IP**.



Part No. 9138002

Axis Part No. 02905-001

Desk Stand

Stand for **2N Clip 2wire-IP**.

Package Completeness Check

Please check the product delivery before installation. Contents:

1x **2N Clip 2wire-IP**

Product Description

1x Certificate of ownership

1x Quick Start manual

1x Metal holder

2x 3 x 12 mm self-tapping lens head screw for holder fitting

2x screw/bolt for wall mounting

2x dowel for wall mounting

1x Doorbell connection terminal (removable)

1x Power supply and data transmission terminal (removable)

2x Tactile sticker

Component Layout

Front

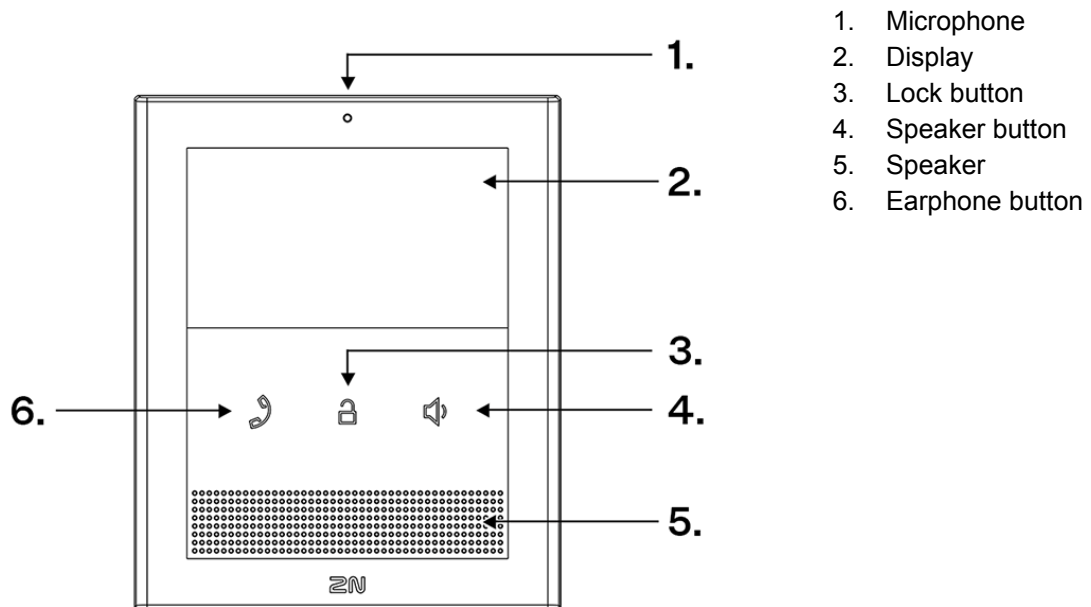

Rear

Product Description

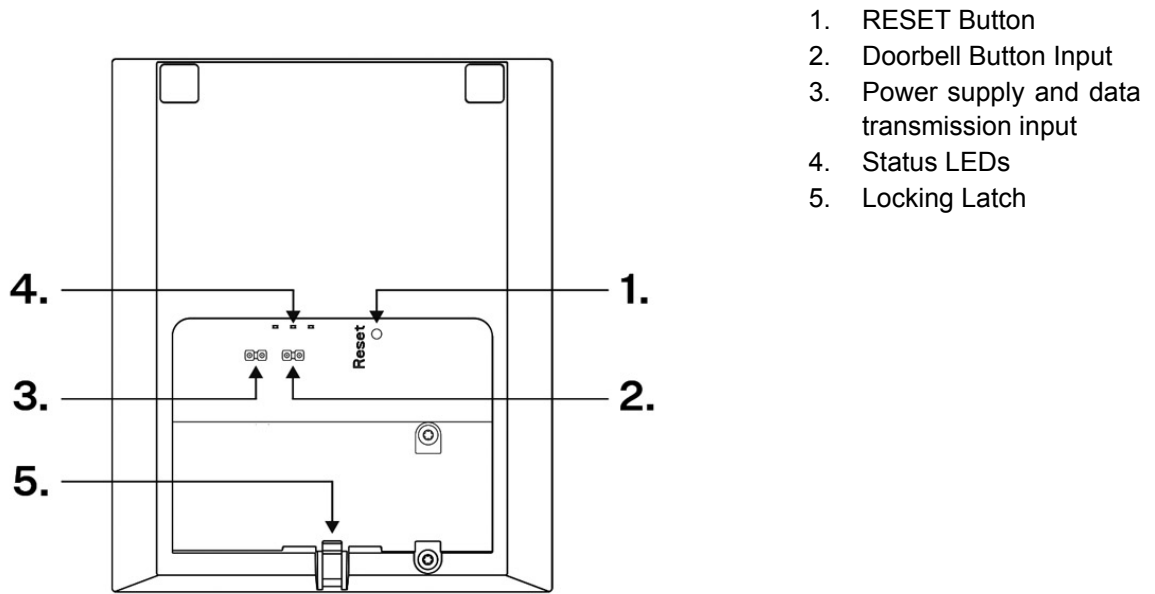

1. RESET Button
2. Doorbell Button Input
3. Power supply and data transmission input
4. Status LEDs
5. Locking Latch

Switch controls and LED

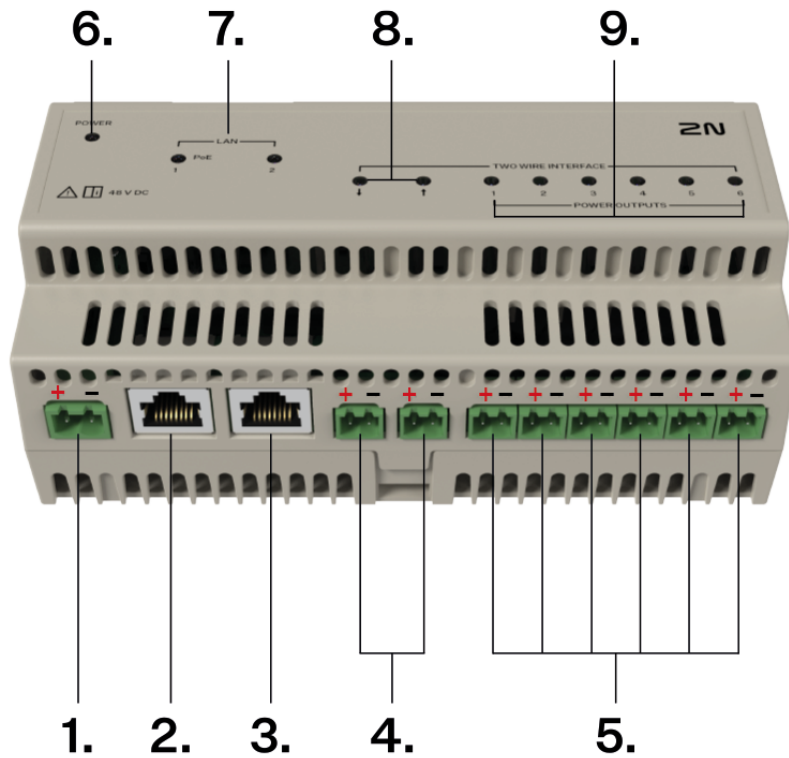

1. Power connector

48 V DC / 1.92 A

Product Description

2.	LAN connector with PoE function (IEEE 802.3af)		Function:	IP device connection floor interconnection via LAN
3.	LAN connector		Function:	IP device connection floor interconnection via LAN
4.	↓ 100 Mbps input/output Leader X ↑ 100 Mbps input/output Follower		Function:	Interconnection between floors with another 2N Clip 2wire-IP switch
5.	10Mbps output (POWER + DATA)		Function:	2N Clip 2wire-IP answering unit connection
6.	POWER	indicates the switch status	illuminated	function of the switch OK
			flashes once in 2 s	USB operations (update, read configuration, write statuses)
			flashes once in 200 ms	initialization or switch function error
7.	LAN	indicates network activity	illuminated	connected
			flashing	activity
			no light signaling	disconnected
8.	TWO WIRE INTERFACE	indicates floor interconnection	illuminated	connected
			flashing	activity
			no light signaling	disconnected

Product Description

9. POWER OUTPUTS	indicates IP device connection	illuminated	connected
		flashing	activity
		no light signaling	disconnected



NOTE

The USB connector is for service purposes only.

Mechanical Installation

This subsection provides the **2N Clip 2wire-IP** installation and connection instructions.

The device can be installed on any of the following ways:

- onto a wall ,
- into a stand (not included in the package).

Installation Conditions



CAUTION

The device mounting and setting should only be performed by professionally qualified persons.

- Exceeding the allowed operating temperature may not affect the device immediately but leads to premature ageing and lower reliability. For the acceptable range of operating temperatures and relative humidity values refer to S. [Technical Parameters \(p. 59\)](#).
- Keep some free space above and below the device to allow air to flow and conduct heat away.
- No strong electromagnetic radiance is allowed on the installation site.
- The device is designed for vertical wall mounting (perpendicular to the floor) in the approximate height of 125 cm above the floor. If necessary, operate the device in a position other than as aforementioned for a short time only, for quick testing purposes in a servicing center, for example.



WARNING

This device must be deployed within a network infrastructure that provides adequate protection against Denial-of-Service (DoS) attacks and similar network-based threats. The device does not include built-in protection against high-volume or malicious traffic and relies on the surrounding network environment—such as firewalls, intrusion prevention systems, or rate limiting—for defense. Failure to implement appropriate network security measures may lead to service degradation or unavailability. The equipment's user documentation shall contain a [description of all exposed network interfaces and all services exposed via network interfaces](#) , which are delivered as part of the factory default state.

Switch Installation

The 2N Clip 2wire-IP switch enables an effective transition from an analog infrastructure to the IP technology using the existing twisted-pair cabling. It provides reliable network connectivity and high-speed data transfer. It supports connection of up to 6 2N Clip 2wire-IP units via a two-wire line. It is suitable for residential buildings, office buildings and commercial buildings where it is important to minimize the reconstruction cost and at the same time ensure modern functionality of the communication system.

The installation must be carried out by a qualified person or firm with electrical expertise to ensure safe operation.

1. Attach the 48 V DC / 1.92 A LPS (Limited Power Source) power supply and the 2N Clip 2wire-IP switch to the DIN rail of the switchboard.
2. Interconnect the switch with the power supply using the low voltage cable included in the switch package. Position the cables so that the correct polarity is maintained. To connect the cable to the switch, use the terminal fitted in the power connector, the cable to the power supply is connected directly.
3. Check the existing twisted pair wiring for a good condition to ensure a proper answering unit connection and operation.
4. Shorten the twisted pair cable to the desired length (the cable length from the switch to the unit should not exceed 100 meters).
5. Mount the terminal placed at the switch connector to the end of the twisted pair for connecting the 2N Clip 2wire-IP answering unit.
6. Connect the attached twisted pair cable to the switch.

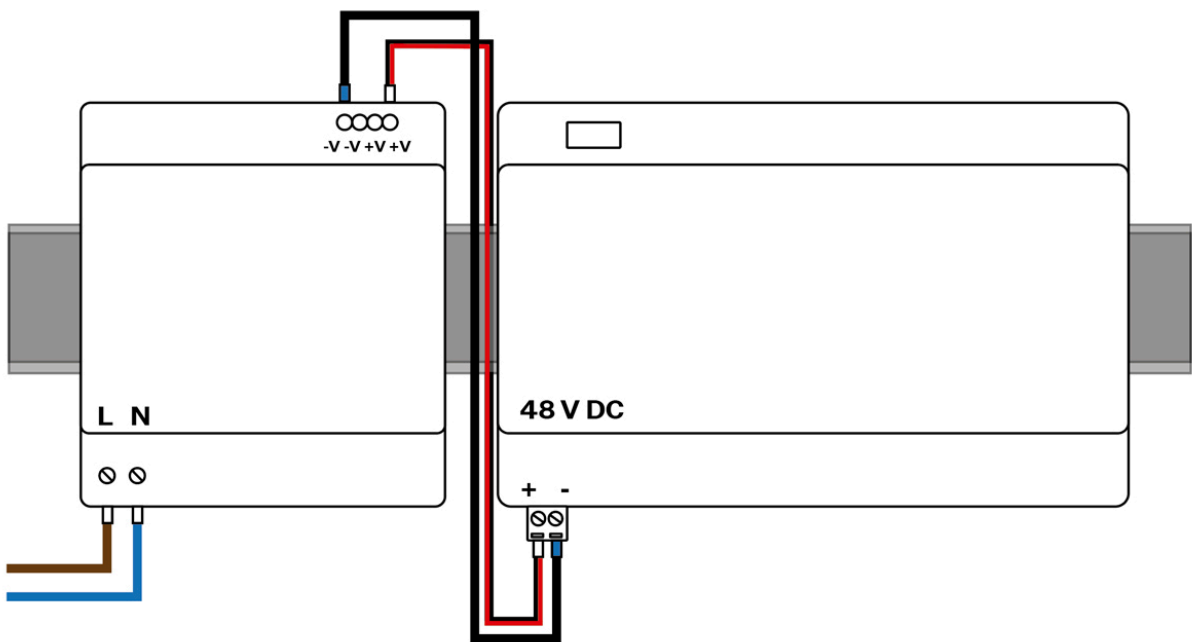

Up to 6 2N Clip 2wire-IP units can be connected to the switch. The correct unit connection is indicated by a permanently lit LED located at the connector position.



CAUTION

- The power supply is intended exclusively for powering one switch. We do not recommend feeding other devices with the same power supply.
- Connection of a defective or improper power supply may lead to a temporary or permanent device failure.
- The length of the wire between the power supply and the switch must not exceed 3 m.
- Observe the polarity as marked on the switch and answering unit connectors.

LAN Connection

To provide a network connection from the main network (LAN), connect a UTP cable to any switch to the LAN connector.

In the case of floor interconnection via UTP cables, see below, it is preferable to use the first or last switch in the row to connect the main network. We recommend a connector without PoE (Power over Ethernet).

2N IP Intercom Connection

To connect an 2N IP intercom, we recommend using a LAN connector with PoE, which is primarily used for IP device connection and provides not only data connection but also power supply.



NOTE

In case more than one IP device need to be connected, an adapter NVT PhyLink can be used (Part No. 1120114). The adapter helps convert the UTP signal to a two-wire connection, allowing you to connect additional devices to the twisted-pair connector. It also provides power from the two-wire interface to the UTP side using the PoE standard.

Floor Interconnection

To interconnect the floors, it is necessary to interconnect the switches with a twisted pair cable or UTP cable. Always observe the correct wiring.



CAUTION

The cable length between the switches should not exceed 50 meters.

Via twisted pair cabling

Plug the cable into the ↓ Leader connector on the first switch in the row. Plug the other end into the ↑ Follower connector on the next switch. Repeat this procedure for all the switches in the row.

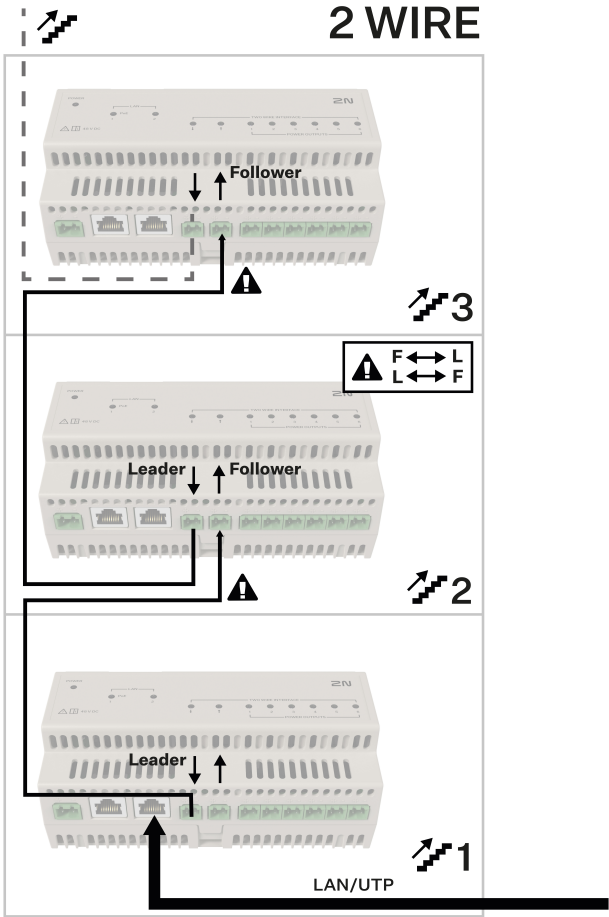

Via UTP cable

Plug the UTP cable into the LAN connector on the first switch in the row. Plug the other end into any LAN connector on the next switch. Repeat this procedure for all the switches in the row.

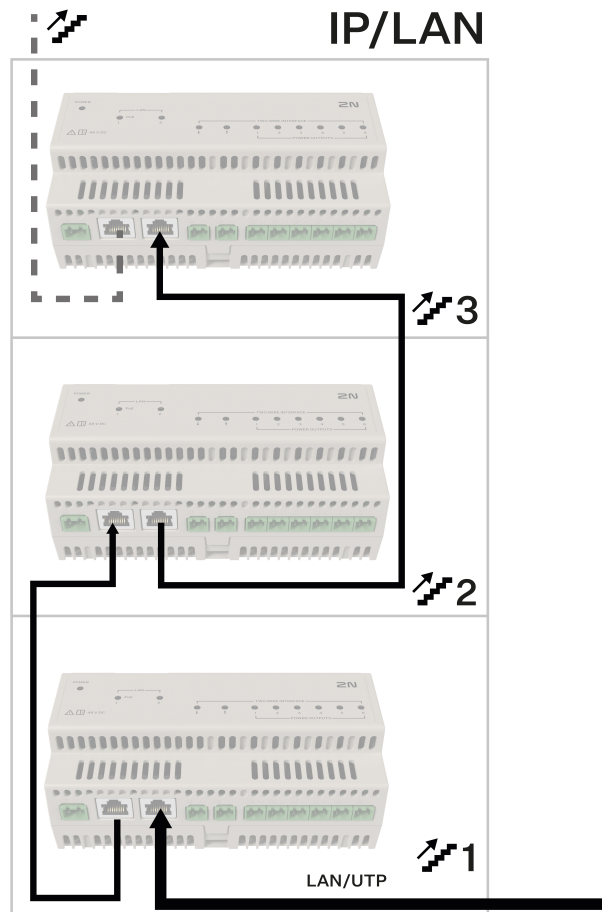

Wall Installation



WARNING

Having unpacked **2N Clip 2wire-IP**, remove the metal holder located on the device back side for installation. Use both your hands at the same time to remove the metal holder safely. A careless removal and insufficient push of the locking latch might lead to a locking latch damage. Follow the below mentioned removal instructions closely!

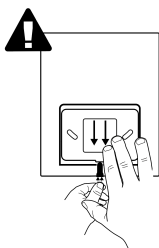

1. Push the locking latch in the center of the device bottom edge with your left hand in such a manner that it bends sufficiently for the metal holder removal. Do not push the locking latch from the top. You might get injured while removing the metal holder.
2. Grasp the metal holder with your right hand and slide it downwards for removal.

2N Clip 2wire-IP is installed directly on the wall using a metal holder or onto a pre-prepared mounting box. The metal holder on the device backside is compatible with the electrical mounting boxes with a fitting hole pitch of 60 mm. A US metal holder is available for installations compatible with single-gang boxes.



NOTE

Screws and dowels for wall mounting are included.

The recommended installation height is 135 cm from the ground. The installation heights may vary depending on the device use.



TIP

Download the Drilling template from 2N.com.

1.

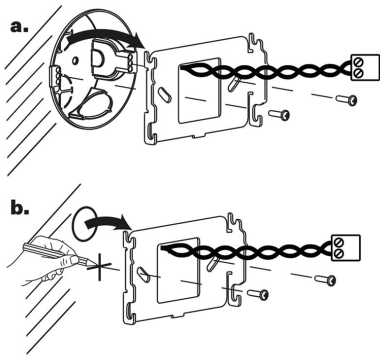

2.

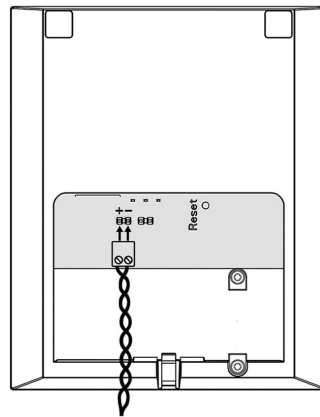

3.

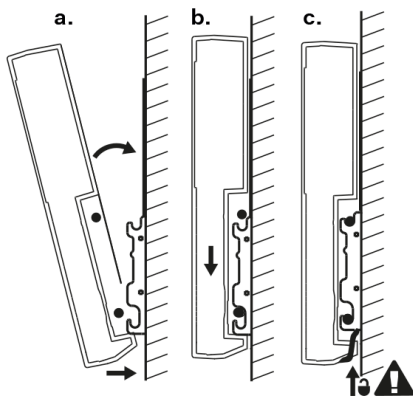

4.

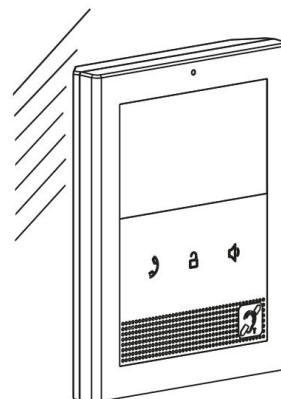

1. Pull the twisted twin cable terminal leading from the wall through the metal holder. Make sure that it is correctly oriented for connection to the device after installation.



TIP

Make sure that the proper orientation is maintained during the holder wall installation. To do this, mark the bulge profile on the holder bottom side.

Remove the cover from the wall-mounted installation box. Take out the pre-prepared cabling, the twisted pair cables, the bell wire.

2. Connect the twisted pair cable to the device.
3.
 - a. Put the device under the holder with its bottom edge first. Then put the device vertically on the wall keeping the device bottom edge under the holder.
 - b. Slide the device gently downwards along the wall.
 - c. Once the locking latch clicks, the device is properly mounted.
4. Now the device is ready for basic operation. It is necessary to perform [software configuration](#) to achieve a full functionality of the device.

Single-Gang Box Mounting

You are advised to use a metal holder (not included in the package) for **2N Clip 2wire-IP** installation in the USA. With the aid of this holder, the device can be installed into universal US single-gang mounting boxes. The device can also be installed directly on a wall without a mounting box.

The recommended installation height is 135 cm from the ground. The installation heights may vary depending on the device use.



TIP

Download the Drilling template from 2N.com.

1a.

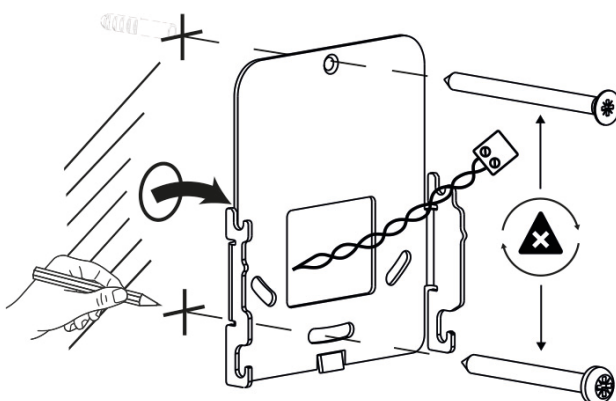

1b.

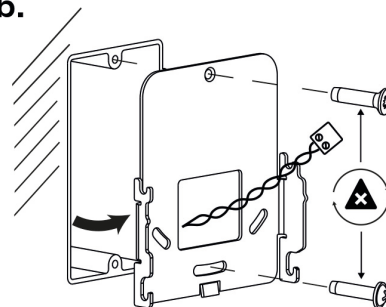

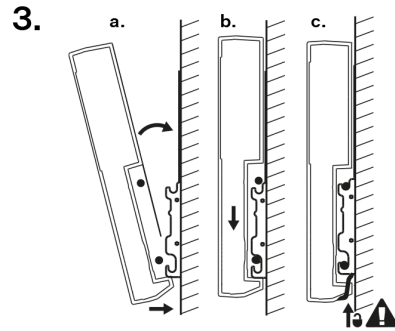
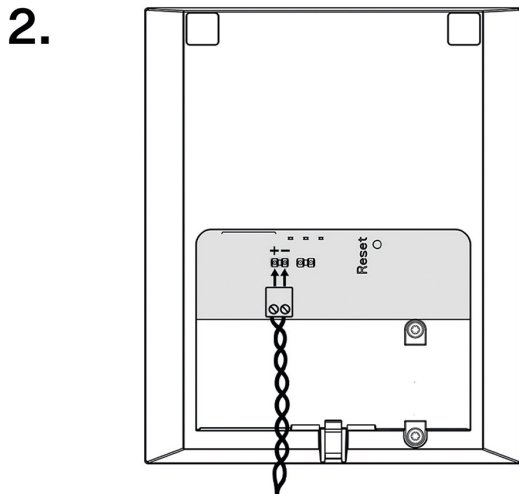

1. Draw the the twisted pair cable fitted with a terminal leading from the wall through the metal holder. Make sure that it is properly oriented for connection to the device after installation. If necessary, align the holder using a level and drill it into the mounting box or on the wall. The wall mounting screws and dowels are not part of the delivery.



CAUTION

During holder installation, it is **necessary** to pay attention to the location of the screws fitting the metal holder to the wall/mounting box. Use a flat head screw for the holder top round hole and a raised head screw for the bottom longitudinal opening. A confusion of the screws might lead to the device damage.

2. Connect the the twisted pair terminal to the device.
3.
 - a. Put the device under the holder with its bottom edge first. Then put the device vertically on the wall keeping the device bottom edge under the holder.
 - b. Slide the device gently downwards along the wall.
 - c. Once the locking latch clicks, the device is properly mounted.
4. Now the device is attached properly. There is a slight distance between the device and the wall due to a rather big size of the metal holder, which is fully compliant with the installation conditions. Now the device is ready for basic operation. It is necessary to perform [software configuration](#) to achieve a full functionality of the device.

Stand Installation

Alternatively, the device can be installed into a stand placed on a desk, for example. The stand is not included in the package.

As part of the installation preparation, take out the pre-prepared cabling, the twisted pair cable, the bell wire. Shorten the cables to the required length. Connect the bell wire to the connector together with the the twisted pair cable for power and data transmission.



WARNING

Having unpacked **2N Clip 2wire-IP**, remove the metal holder located on the device back side for installation. Use both your hands at the same time to remove the metal holder safely. A careless removal and insufficient push of the locking latch might lead to a locking latch damage. Follow the below mentioned removal instructions closely!

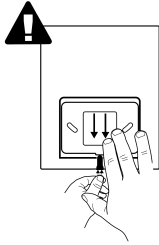

- a. Push the locking latch in the center of the device bottom edge with your left hand in such a manner that it bends sufficiently for the metal holder removal. Do not push the locking latch from the top. You might get injured while removing the metal holder.
- b. Grasp the metal holder with your right hand and slide it downwards for removal.

1a.

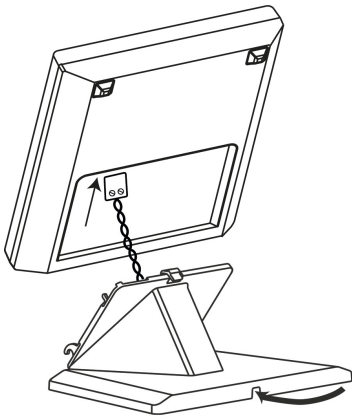

1b.

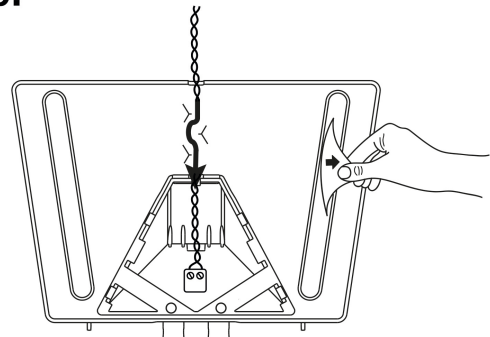

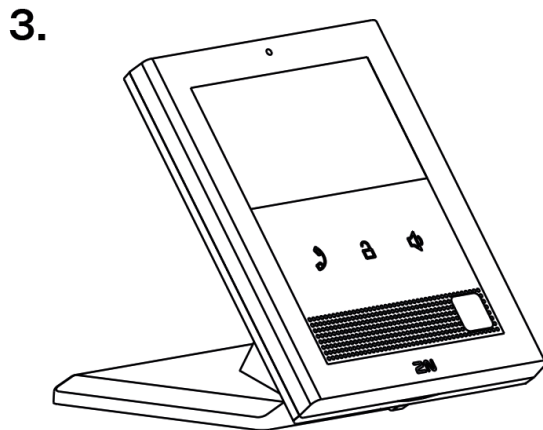
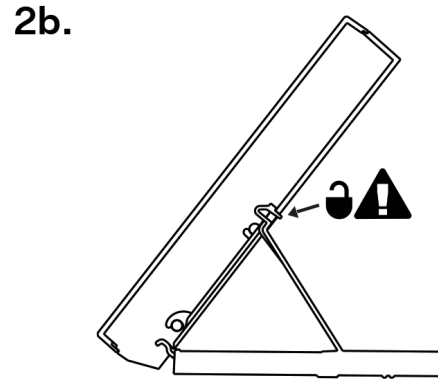
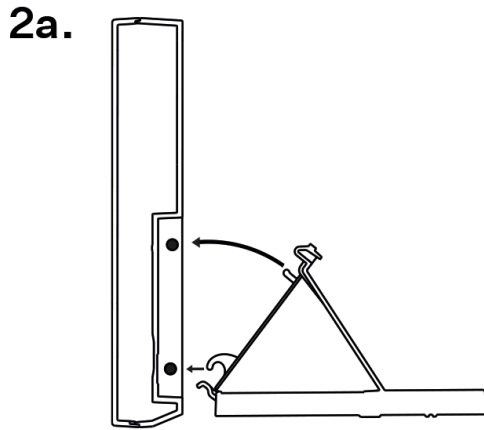

1. Pull the prepared twisted pair cable fitted with a terminal through the bottom of the stand and connect it on the DATA&SUPPLY input. Place the cable in the groove in the middle of the stand base. Remove the protective film from the non-slip surfaces of the stand.
2. Put the stand including the properly drawn and connected cable on the device. First snap in the stand hooks, then tilt the stand towards the device and lock the latches on the stand top edge into the device body.
3. Now the device is ready for basic operation. It is necessary to perform [software configuration](#) to achieve a full functionality of the device.

Device Removal

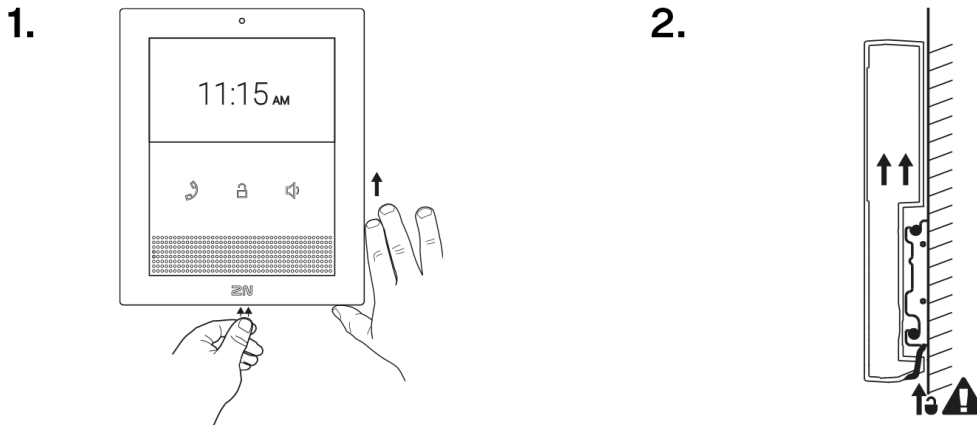

1. Press the locking latch located in the center of the device back bottom edge. Pull the device gently upwards to release it from the metal holder/stand.
2. Remove the device from the hooks and take it away safely.

Power Supply

2N Clip 2wire-IP is powered via a 2N 2wire-IP Bus from the 2N Clip 2wire-IP switch.

Each 2N Clip 2wire-IP switch is powered by an external power supply. We recommend using the Mean Well HDR-100-48 (1120302, 03479-001) rated at 48 V DC, 1.92 A.

Supply type

2N 2wire-IP bus, 48 V DC nominal

Technical Parameters



CAUTION

This device cannot be connected directly to telecom lines (or public wireless networks) of any telecom service providers (i.e. mobile providers, landline providers or Internet providers). A router has to be used for the device Internet connection.



WARNING

- We recommend securing each power supply for the 2N Clip 2wire-IP switch (1120302, 03479-001) in the installation with its own circuit breaker. If multiple power supplies are connected to a single circuit breaker, we recommend purchasing a Mean Well ICL-16R inrush current limiting module in the free market.

Tactile stickers

Special tactile stickers with raised surfaces are included in the package. These stickers help people with visual impairments to recognize the basic controls of the device.

We recommend placing the sticker next to the incoming call receiving button.



NOTE

Clean the device surface from dust and dirt before applying the sticker.

Brief Guidelines

IP Address Retrieval

To retrieve the device IP address, take the following steps:

- Use the freely accessible 2N IP Utility.
- Display information on the device display.
- Use hardware (RESET button).

IP Address Retrieval Using 2N IP Utility

The 2N IP Utility application helps find the 2N device IP address in the LAN. Download 2N IP Utility from the [2N.com](https://www.2n.com) website. Make sure that Microsoft .NET Framework 4.7.2 is installed for successful app installation.

1. Run the 2N IP Utility installer.
2. The Installation Wizard will help you with the installation.
3. Having installed 2N IP Utility, start the application using the Microsoft Windows Start menu. Once started, the application begins to automatically search the LAN for all the 2N and AXIS devices which have been DHCP/statically assigned IP addresses. These devices are then shown in a table.

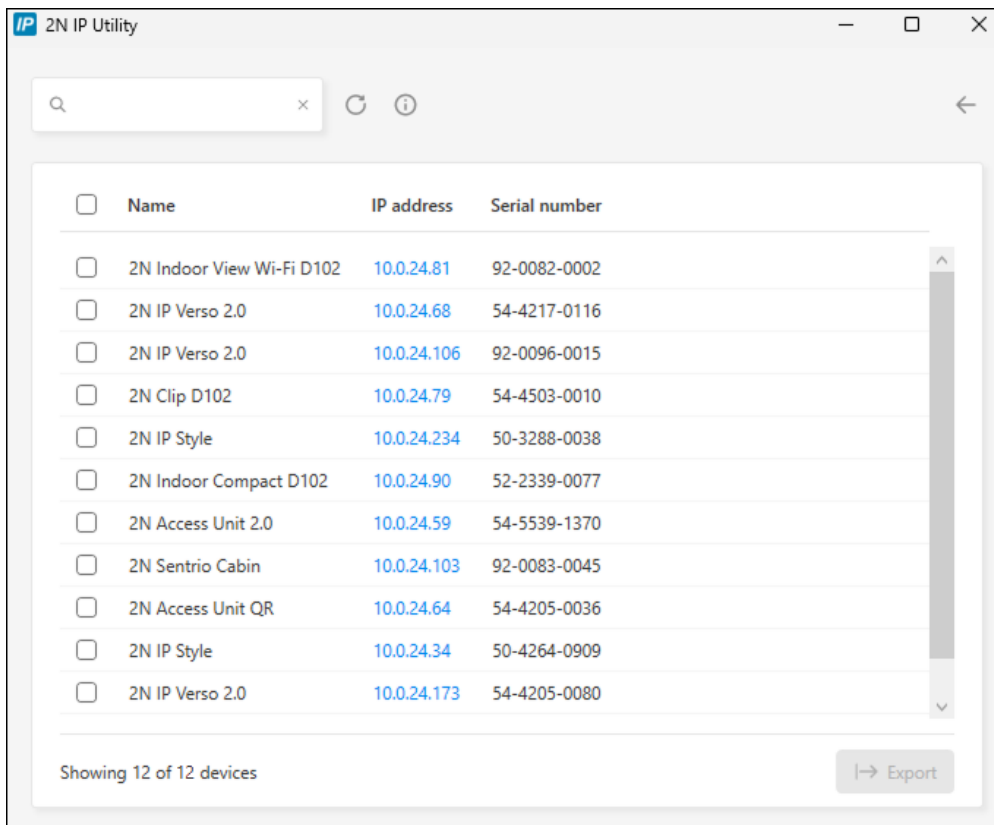

4. Select the device to be configured and left-click it. This opens the right-hand part of the web configuration interface window.



TIP

- Access to the web configuration interface is also possible via the **Open in external browser** button, which opens the interface in a separate browser window.
- Click a device in the list to display detailed information. Click the **IP settings** button to change the IP address by entering the required static IP address or activating DHCP.
- The application also allows you to export selected devices into a CSV file. First select a device by ticking the boxes in the list, then use the **Export** button that appears at the bottom of the window. The exported file shall include the names, IP addresses and serial numbers of the selected devices.

The default login data are:

Username: **Admin**

Password: **2n**

It is necessary to change the password immediately upon the first login.





TIP

It is recommended that a password is used that is difficult to break. It is not recommended that names, places or things, especially those closely related to the user, are used in the password.

For increased password security, it is recommended that:

- the random password generator is used,
- the password length is 12 characters at least,
- various characters from different character sets are combined (small/capital letters, digits, special characters, etc.).

IP Address Retrieval using Device Display

To find the device IP address on the device, click any button to quit the Idle mode. The [Settings menu \(p. 50\)](#) is displayed on the Home screen after a long press of the earpiece  and speaker  buttons. Find the IP address information in About device.

IP Address Retrieval Using the RESET button

Follow the instructions below to retrieve the current IP address:

1. Press the button RESET and keep it pressed.
 - a. Wait until the red and green LEDs go on simultaneously on the device and the acoustic signal can be heard  (approx. 15–35 s).
2. Release the RESET button.

3. The device announces the current IP address via the speaker automatically.

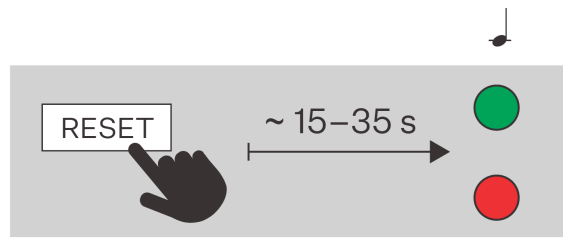

NOTE

The delay after pressing RESET till the first light and sound signaling is set to 15–35 s depending on the device model used.

Access to web device configuration

Configure **2N Clip 2wire-IP** via a web configuration interface, which is accessible from a web browser.



You need to know the IP address or domain name of the device for access to the interface. Make sure that the device is connected to the local IP network and powered.

The web configuration interface can also be accessed from the connected My2N portal or the 2N Access Commander configuration tool.

Web Configuration Interface Login

1. Start your Internet browser.
2. Enter the device IP address or domain name (refer to Subs.[Finding devices in the network \(p. 32\)](#)).
3. If no certificate has been generated for the IP address, a security certificate invalidity notification may appear. In that case, confirm that you want to go to the web configuration interface.
4. The login screen is now displayed.
5. Enter the login data.
The default login data are:
 - Username: **Admin**
 - Password: **2n**
6. After the first login, change the password.

Access from 2N Access Commander

1. Log in to the Access Commander interface.
2. Go to the  Devices page.
3. For the selected device, press .

Password Change

You must change the default password to get full access to the web configuration interface features. You cannot configure the device without changing the default password.



TIP

It is recommended that a password is used that is difficult to break. It is not recommended that names, places or things, especially those closely related to the user, are used in the password.

For increased password security, it is recommended that:

- the random password generator is used,
- the password length is 12 characters at least,
- various characters from different character sets are combined (small/capital letters, digits, special characters, etc.).

Recommended browsers

The web configuration interface is optimized for the Chromium-based web browsers (Google Chrome, Microsoft Edge or Opera, e.g.). With other browsers, there may be slight differences in the interface function and appearance.

Firmware Update

New firmware versions are available on the update server. If the web configuration interface does not provide access to the public Internet, it is possible to upload the firmware file manually to the device.



NOTE

Firmware updates are not automatic. To ensure system integrity and eliminate unintentional failures, all updates must be manually confirmed or initiated by the user. Please check the release notes of the new version and verify compatibility with your existing infrastructure before performing any updates.

Getting Firmware from Update Server



CAUTION

In version 3.0.0, firmware updates from the update server are only available from the older version of the web interface.

- a. Click [Go to the old interface](#) in the web configuration interface header.

1. Go to **System > Maintenance > Firmware**.
2. Click [Check for Updates](#).
3. If an update is available, its release notes are loaded. To start the upgrade, click [Upgrade](#) in the window header.
4. Once the firmware is uploaded successfully, the device is restarted automatically. After the restart, the device becomes fully operational with a new firmware version. The FW upgrade does not affect configuration.

Uploading New Firmware from Storage

1. Go to **System > Maintenance > Firmware**.
2. Click **Upload Firmware**.
3. In the open dialog box, select a file from your own storage.
4. Click **Upload** to confirm the file upload.
The device checks the firmware file and prevents you from uploading an incorrect or corrupt file.
5. Once the firmware is uploaded successfully, the device is restarted automatically. After the restart, the device becomes fully operational with a new firmware version. The FW upgrade does not affect configuration.

Device Restart

To restart the device choose one of the following options:

- using power disconnection and reconnection
- via the web configuration interface.
- using the device buttons
- using the RESET button,





The device restart does not result in any change in the configuration settings.

Restart Using Web Configuration Interface

1. Open the web configuration interface.
2. Go to **System > Maintenance**.
3. Press **Restart Device** in the page header.

The [Home screen \(p. 48\)](#) is displayed after restart. Restarting may take a rather long time after the button press.

Restart Using Device Buttons

Press the  and  buttons on the device simultaneously for a long time to display the Settings menu. Click  to select Device administration > Device restart (press  for confirmation). Press  again to complete the restart. The device is then restarted.

The [Home screen \(p. 48\)](#) is displayed after restart. Restarting may take a rather long time after the button press.

Restart Using RESET Button

Press the button shortly (< 1 s) to restart the system without changing configuration.

Find the RESET button on the [device backside \(p. 8\)](#).

The [Home screen \(p. 48\)](#) is displayed after restart. Restarting may take a rather long time after the button press.

Factory Default Reset

The factory settings can be restored

- via the web configuration interface.
- Use hardware (RESET button).

Factory Default Reset via Web Configuration Interface

Soft reset the device factory default values in **System > Maintenance** using Default Reset.

Factory Default Reset with RESET Button

1. Press the button RESET and keep it pressed.
 - a. Wait until the red and green LEDs go on simultaneously on the device and the acoustic signal can be heard 🎵 (approx. 15–35 s).
 - b. Wait until the red LED goes off and an acoustic signal can be heard 🎵 (approx. for another 3 s).
 - c. Wait until the green LED goes off and the red LED goes on again and an acoustic signal can be heard 🎵 (approx. for another 3 s).
 - d. Wait until the red LED goes off and the acoustic signal can be heard 🎵 (approx. for another 3 s).
2. Release the RESET button.

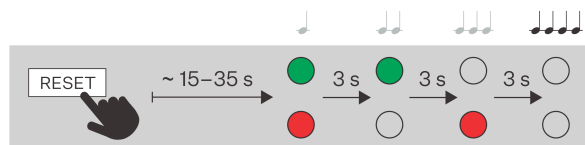

Configuration via Hardware

Where software configuration is unavailable, make basic settings using the RESET button (refer to 1.).

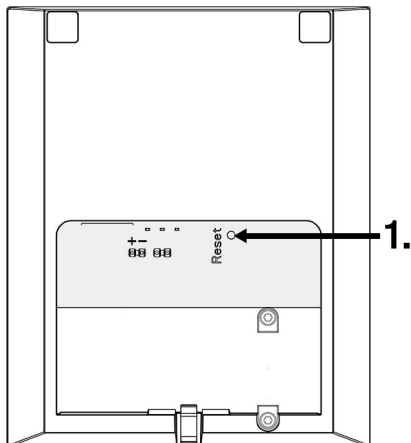

The RESET button helps you retrieve the device IP address, switch the dynamic/static IP address mode or reset the factory values.

Device Restart

Press the button shortly (< 1 s) to restart the system without changing configuration.



CAUTION

Do not touch the display during reboot, it is being calibrated.

IP Address Retrieval Using the RESET button

Follow the instructions below to retrieve the current IP address:

1. Press the button RESET and keep it pressed.
 - a. Wait until the red and green LEDs go on simultaneously on the device and the acoustic signal can be heard 🎵 (approx. 15–35 s).
2. Release the RESET button.
3. The device announces the current IP address via the speaker automatically.



NOTE

The delay after pressing RESET till the first light and sound signaling is set to 15–35 s depending on the device model used.

Static IP Address Setting with RESET Button

Follow the instructions below to switch on the Static IP address mode (DHCP OFF):

1. Press the button RESET and keep it pressed.
 - a. Wait until the red and green LEDs go on simultaneously on the device and the acoustic signal can be heard 🎵 (approx. 15–35 s).
 - b. Wait until the red LED goes off and an acoustic signal can be heard 🎵🎵 (approx. for another 3 s).
2. Release the RESET button.

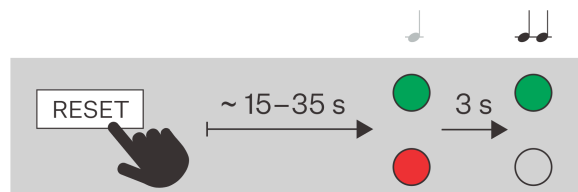



NOTE

The following network parameters will be set after restart:

- IP address: 192.168.1.100
- Network mask: 255.255.255.0
- Default gateway: 192.168.1.1



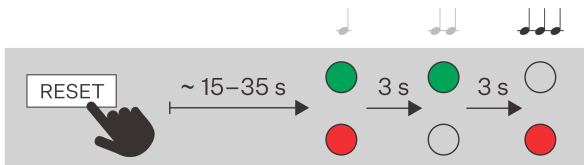

Dynamic IP Address Setting via RESET

Follow the instructions below to switch on the Static IP address mode (DCHP ON):

1. Press the button RESET and keep it pressed.
 - a. Wait until the red and green LEDs go on simultaneously on the device and the acoustic signal can be heard  (approx. 15–35 s).
 - b. Wait until the red LED goes off and an acoustic signal can be heard  (approx. for another 3 s).
 - c. Wait until the green LED goes off and the red LED goes on again and an acoustic signal can be heard  (approx. for another 3 s).
2. Release the RESET button.



Factory Default Reset with RESET Button

1. Press the button RESET and keep it pressed.
 - a. Wait until the red and green LEDs go on simultaneously on the device and the acoustic signal can be heard  (approx. 15–35 s).
 - b. Wait until the red LED goes off and an acoustic signal can be heard  (approx. for another 3 s).
 - c. Wait until the green LED goes off and the red LED goes on again and an acoustic signal can be heard  (approx. for another 3 s).
 - d. Wait until the red LED goes off and the acoustic signal can be heard  (approx. for another 3 s).
2. Release the RESET button.

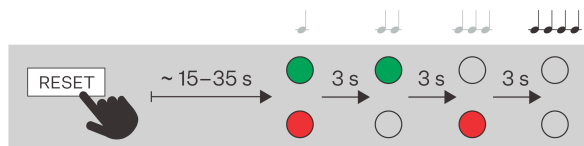

Web configuration interface

Indoor Stations

First Login

Finding devices in the network

You need to know the IP address or domain name of the device for access to the interface. Make sure that the device is connected to the local IP network and powered.

Domain Name

To access the web configuration interface, you can enter the domain name into the browser in the format “hostname.local” instead of the IP address. The hostname of a new device consists of the product name and serial number of the device. While entering a hostname, use only letters and digits; do not use spaces, periods, dashes, or other special characters.

Default domain name 2N Clip 2wire-IP: Clip 2wire-IP-{serial number without dashes}.local (e.g.: “Clip 2wire-IP-0000000001.local”)

The format of the device name is specified in the Installation Manual for the specific product in the Domain Name subsection.



TIP

You can change the hostname later in the web configuration interface at **System > Network Connection > Advanced Configuration > Hostname**.

Login based on a domain name is advantageous if the dynamic IP address is used. While the dynamic IP address changes, the domain name remains the same. It is possible to generate certificates signed by a trusted certification authority for the domain name.

Device IP Address

By factory default, **2N Clip 2wire-IP** uses a dynamic IP address assigned by the DHCP server.

The 2N IP Utility application helps find the 2N device IP address in the LAN. Download 2N IP Utility from the 2N.com website. Make sure that Microsoft .NET Framework 4.7.2 is installed for successful app installation.

Depending on the capabilities of the device, you can also retrieve the IP address in one of the following ways:

- with the RESET button
- on the device display (see the product Installation Manual for the procedure)

IP Address Retrieval Using 2N IP Utility

The 2N IP Utility application helps find the 2N device IP address in the LAN. Download 2N IP Utility from the 2N.com website. Make sure that Microsoft .NET Framework 4.7.2 is installed for successful app installation.

1. Run the 2N IP Utility installer.
2. The Installation Wizard will help you with the installation.

Web configuration interface

- Having installed 2N IP Utility, start the application using the Microsoft Windows Start menu. Once started, the application begins to automatically search the LAN for all the 2N and AXIS devices which have been DHCP/statically assigned IP addresses. These devices are then shown in a table.

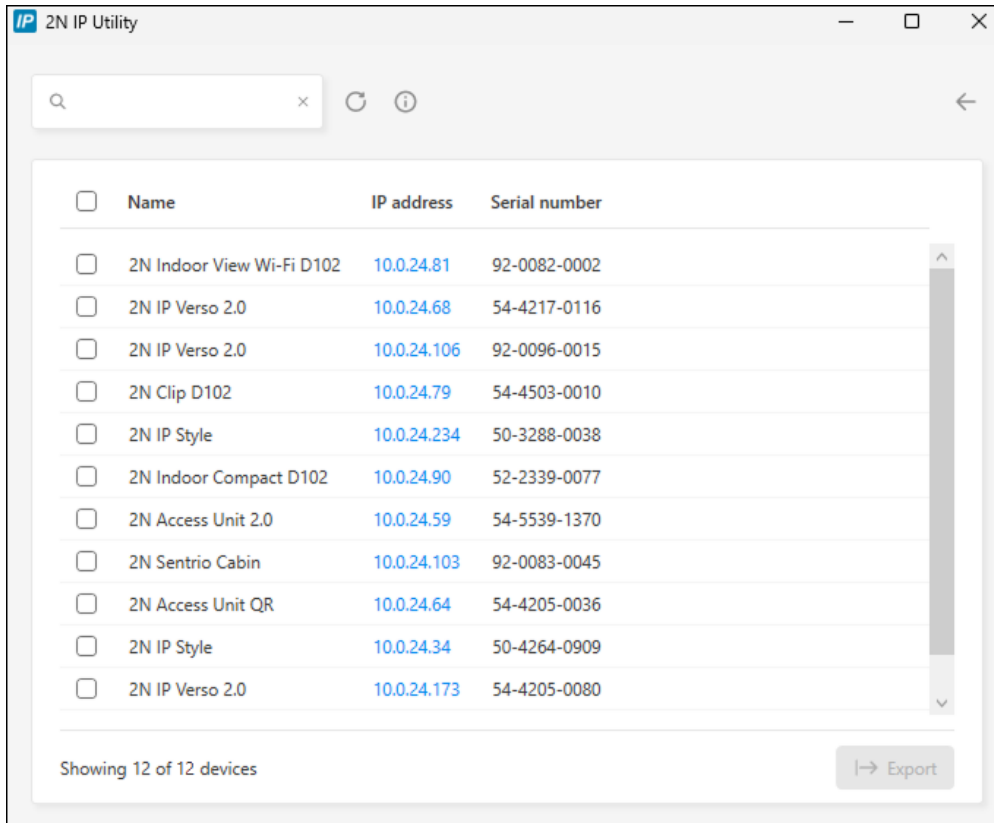

- Select the device to be configured and left-click it. This opens the right-hand part of the web configuration interface window.



TIP

- Access to the web configuration interface is also possible via the **Open in external browser** button, which opens the interface in a separate browser window.
- Click a device in the list to display detailed information. Click the **IP settings** button to change the IP address by entering the required static IP address or activating DHCP.
- The application also allows you to export selected devices into a CSV file. First select a device by ticking the boxes in the list, then use the **Export** button that appears at the bottom of the window. The exported file shall include the names, IP addresses and serial numbers of the selected devices.

The default login data are:

Username: **Admin**

Password: **2n**

It is necessary to change the password immediately upon the first login.



TIP

It is recommended that a password is used that is difficult to break. It is not recommended that names, places or things, especially those closely related to the user, are used in the password.

For increased password security, it is recommended that:

- the random password generator is used,
- the password length is 12 characters at least,
- various characters from different character sets are combined (small/capital letters, digits, special characters, etc.).

IP Address Retrieval Using the RESET button

Follow the instructions below to retrieve the current IP address:

1. Press the button RESET and keep it pressed.
 - a. Wait until the red and green LEDs go on simultaneously on the device and the acoustic signal can be heard (approx. 15–35 s).
2. Release the RESET button.
3. The device announces the current IP address via the speaker automatically.

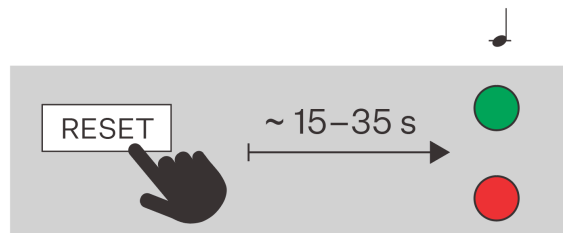

NOTE

The delay after pressing RESET till the first light and sound signaling is set to 15–35 s depending on the device model used.

DHCP Switching

By factory default, **2N Clip 2wire-IP** uses a dynamic IP address assigned by the DHCP server.

Dynamic IP Address

DHCP (Dynamic Host Configuration Protocol) is a network protocol that maintains a list of available IP addresses and automatically assigns them to devices in the LAN. The assigned IP address is dynamic, so the device can be assigned a new IP address after a period of time (lease time).

Static IP Address

If the IP address of the device is to remain unchanged, you must disable IP address allocation by the DHCP server on the device. You can disable the DHCP server in the web configuration interface or using the device hardware.



NOTE

The specific values for the static IP address can only be set in the web configuration interface of the device.

Setting Network Parameters in Web Configuration Interface

1. Go to the web configuration interface.
2. Go to **System > Network Connection > Basic Settings > IP Address Settings**.
3. Set the desired network parameters.
4. Save your changes.

Switching DHCP on Device Hardware

Depending on the capabilities of the device, the IP address can be switched as follows:

- with the RESET button



TIP

Please refer to the product Installation Manual for the location of the RESET button.

Dynamic IP Address Setting via RESET

Follow the instructions below to switch on the Static IP address mode (DCHP ON):

1. Press the button RESET and keep it pressed.
 - a. Wait until the red and green LEDs go on simultaneously on the device and the acoustic signal can be heard 🎵 (approx. 15–35 s).
 - b. Wait until the red LED goes off and an acoustic signal can be heard 🎵 (approx. for another 3 s).
 - c. Wait until the green LED goes off and the red LED goes on again and an acoustic signal can be heard 🎵🎵 (approx. for another 3 s).
2. Release the RESET button.

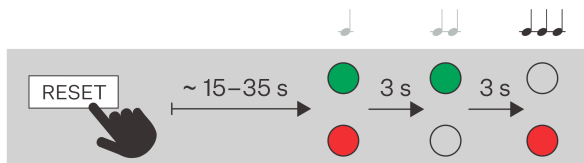

Static IP Address Setting with RESET Button

Follow the instructions below to switch on the Static IP address mode (DHCP OFF):

1. Press the button RESET and keep it pressed.
 - a. Wait until the red and green LEDs go on simultaneously on the device and the acoustic signal can be heard 🎵 (approx. 15–35 s).
 - b. Wait until the red LED goes off and an acoustic signal can be heard 🎵 (approx. for another 3 s).

2. Release the RESET button.

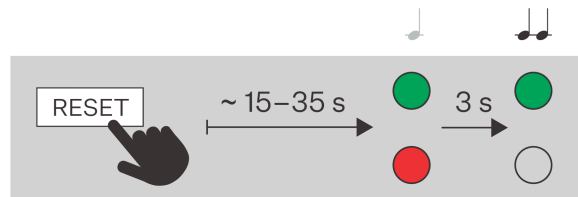

NOTE

The following network parameters will be set after restart:

- IP address: 192.168.1.100
- Network mask: 255.255.255.0
- Default gateway: 192.168.1.1

Access to web device configuration

Configure **2N Clip 2wire-IP** via a web configuration interface, which is accessible from a web browser.



You need to know the IP address or domain name of the device for access to the interface. Make sure that the device is connected to the local IP network and powered.

The web configuration interface can also be accessed from the connected My2N portal or the 2N Access Commander configuration tool.

Web Configuration Interface Login

1. Start your Internet browser.
2. Enter the device IP address or domain name (refer to Subs.[Finding devices in the network \(p. 32\)](#)).
3. If no certificate has been generated for the IP address, a security certificate invalidity notification may appear. In that case, confirm that you want to go to the web configuration interface.
4. The login screen is now displayed.
5. Enter the login data.
The default login data are:
 - Username: **Admin**
 - Password: **2n**
6. After the first login, change the password.

Access from 2N Access Commander

1. Log in to the Access Commander interface.
2. Go to the  Devices page.
3. For the selected device, press .

Password Change

You must change the default password to get full access to the web configuration interface features. You cannot configure the device without changing the default password.



TIP

It is recommended that a password is used that is difficult to break. It is not recommended that names, places or things, especially those closely related to the user, are used in the password.

For increased password security, it is recommended that:

- the random password generator is used,
- the password length is 12 characters at least,
- various characters from different character sets are combined (small/capital letters, digits, special characters, etc.).

Recommended browsers

The web configuration interface is optimized for the Chromium-based web browsers (Google Chrome, Microsoft Edge or Opera, e.g.). With other browsers, there may be slight differences in the interface function and appearance.

Basic Device Settings

Firmware Update

New firmware versions are available on the update server. If the web configuration interface does not provide access to the public Internet, it is possible to upload the firmware file manually to the device.



NOTE

Firmware updates are not automatic. To ensure system integrity and eliminate unintentional failures, all updates must be manually confirmed or initiated by the user. Please check the release notes of the new version and verify compatibility with your existing infrastructure before performing any updates.

Getting Firmware from Update Server



CAUTION

In version 3.0.0, firmware updates from the update server are only available from the older version of the web interface.

- a. Click [Go to the old interface](#) in the web configuration interface header.

1. Go to **System > Maintenance > Firmware**.
2. Click [Check for Updates](#).
3. If an update is available, its release notes are loaded. To start the upgrade, click [Upgrade](#) in the window header.
4. Once the firmware is uploaded successfully, the device is restarted automatically. After the restart, the device becomes fully operational with a new firmware version. The FW upgrade does not affect configuration.

Uploading New Firmware from Storage

1. Go to **System > Maintenance > Firmware**.
2. Click **Upload Firmware**.
3. In the open dialog box, select a file from your own storage.
4. Click **Upload** to confirm the file upload.
The device checks the firmware file and prevents you from uploading an incorrect or corrupt file.
5. Once the firmware is uploaded successfully, the device is restarted automatically. After the restart, the device becomes fully operational with a new firmware version. The FW upgrade does not affect configuration.

Directory

The Directory section is a key part of the device configuration. In the directory, you can create users and their phone connection parameters.

Adding User Manually to Directory

1. Click **Add User** on the Directory page.
2. The user detail will open. Name the user on the Personal Information tab.
3. Set the device phone number of the contact according to [Creating Calling Contacts \(p. 38\)](#).

Bulk User Management in Access Commander or My2N

If the device is managed through the Access Commander or My2N bulk configuration tools, any changes made in the web configuration interface are overwritten by the settings in the bulk configuration tool. A user created directly in the web interface will be deleted.

The **Holder** column in the Directory table specifies the bulk configuration tool that created the user. The **Holder** column is hidden by default.

Calling

The 2N device provides several ways of connecting calls. Before creating contacts and setting the dialing method, you must first activate and set the call mediating services:

- [Calling via SIP \(p. 39\)](#)
- [Local Calls between 2N Devices \(p. 40\)](#)
- other special integrations

Creating Calling Contacts

Creating a calling contact consists of adding a phone number to the corresponding user in the device directory.



TIP

You can use the Local calls function to connect to another 2N device in your LAN, refer to [Adding 2N Local Device \(p. 39\)](#).

1. Go to **Directory**.
2. Open the user detail by clicking on the row or select **Add User** to create a new user.
3. On the **Phone Numbers** tab, click  to open the phone number editing.

4. Select **Call Type** for the contact (SIP, local network, MS Teams, VMS, ...).
 - [Calling via SIP \(p. 39\)](#) – for VoIP services and accounts
 - [Local Calls between 2N Devices \(p. 40\)](#) – for calls to 2N devices
 - MS Teams, VMS,... – for special integrations
5. Enter the destination number or address for the device to call.
Enter the extension number, SIP URI (e.g. “sip:101@192.168.1.50”), domain name (e.g. “2NIPVer-so20-22222222” or another number as set in the Call Type) as necessary.
6. Set additional call features that affect the call behavior in **Options**.
These options allow the administrator to configure the security, functionality and dialing logic to suit the exact needs of the facility, for example, to use encrypted transmission, speed up the connection or enable door reverse opening.
7. Specify the time limit when the number can be called in the **Availability** section. For example, you can set availability only for the user's working hours.
8. Click **Confirm** to save the change.

Adding 2N Local Device



CAUTION

Local Calls must be enabled on both this and the device to be searched with the identical **Access Key**, refer to [Local Calls between 2N Devices \(p. 40\)](#).

1. Click **Add Local Device** on the **Directory** page.
2. In the open dialog box, check the device to get connected to.
3. Select **Add to Directory**.
4. A new user appears in the directory with one phone number set.
5. Click the user row to edit it further.

Dialing Calls on Device

The dialing method for specific contacts is set directly in the contact detail in the directory.

Calling via SIP

Device Registration to SIP Server

Registration to the SIP server is crucial for full functionality of the device in a SIP environment.

1. Go to **Calling > SIP** of the account to be set up.
2. Enable the SIP account at the top.
3. On the **Device Identity** tab, fill in:
 - **Display Name** – this text will be displayed to the other party as caller ID.
 - **Phone Number (ID)** – together with the domain, this number uniquely identifies the device in calls and registration.
 - **Domain** – set the domain name of the service with which the device is registered. Typically, it is equivalent to the SIP Proxy or SIP Registrar address.These three values combined identify the device in the SIP environment.
4. In **Authentication**, fill in the login credentials assigned by the SIP server administrator to authenticate the device to the SIP Proxy server. This authentication prevents unauthorized access, fraudulent calls or identity fraud.
If **Authentication ID** is not filled in, the device will authenticate with **Phone Number**.
5. Under **Transport Protocol Options**, select the protocol to be used by the SIP server.
6. Enable the **SIP Registrar** feature.

- Fill in the details of the SIP registrar with which you want to register the 2N device.
If you leave the **Port** parameter empty or the parameter value is 0, the default port is applied according to the selected transport protocol.

Default Port Values according to Transport Protocol

Account	UDP / TCP	TLS
SIP 1	5060	5061
SIP 2	5062	5063
SIP 3	5064	5065
SIP 4	5066	5067

- The tab header shows the registration status and the registration error messages.



NOTE

Further SIP account settings are described in Subs. [Advanced SIP Account Settings \(p. 42\)](#).

Setting Public Device IP Address

This setting is used when the device is located behind a router (NAT) and communicates with the PBX outside the LAN (in the cloud or over the Internet, e.g.). In SIP communication, the device must specify the public IP address under which it is accessible from the Internet. If it sent its internal IP address, the PBX would not be able to route the call or RTP data stream correctly.

If the device and the PBX are on one and the same LAN, it is unnecessary to set the public IP address.

- Go to **Calling > SIP** of the account to be set up.
- On the **Public IP Address** tab select one of the following options:
 - STUN (Automatic)**
Fill in the details of your STUN server.
 - Enter Manually**
Enter your own external IP address for the device.

Local Calls between 2N Devices

It is possible to set up the so-called local calls between the 2N IP devices, which allow for direct communication between 2N devices within one LAN without the need to connect to a SIP server or external infrastructure.

Activating Local Calls

- Go to **Calls > Local Calls**.
- Enable the feature in the page header.

3. Set the access keys to ensure secure communication with other devices on the network.
The access keys ensure that only devices with identical keys can communicate with each other. This contributes to security and the ability to define independent groups of devices.

Display Settings

Custom Display Language Upload

The web configuration interface allows you to customize the language texts displayed on the device. Thus, you can adapt the device to a different language environment or display custom messages.

1. In the web configuration interface, go to **Customization > Display**.
2. Download the translation file template on the **Language** tab. The template contains default English texts.
3. Open the downloaded file in a text editor.
4. Replace the English expressions in the file with your own texts.



CAUTION

Do not change the structure and format of the key phrases. If the syntax is modified or some items are missing, the translation file may not load correctly.

5. Save the modified file in the format `.ini`.
6. Return to the **Language** tab in the web interface and select “Custom” from the language drop-down menu.
7. The file upload option will appear – select and upload your modified `.ini` file.
8. Save the changes after successful upload.

Advanced Settings

Sound Settings

Device Volume Setting

To adjust the volume of your device, go to **Customization > Audio**.

Audio Transmission in Calls

The call audio parameters are set directly on the tab of the service that provides the call ([Calling via SIP \(p. 39\)](#) or [Local Calls between 2N Devices \(p. 40\)](#)), in the **Video** folder.

1. Open the **Calling** section.
2. Go to the page of the service providing the call (specific SIP account, Local calls).
3. Open the **Audio** tab.
4. Here set the necessary sound parameters.

DTMF Signal Transmission Enable

It is possible to switch on the door lock and thus open the door using the DTMF commands sent to this device.

1. Open the **Calling** section.
2. Go to the page of the service providing the call (specific SIP account, Local calls).
3. Open the **Audio** tab.
4. On the **Sending DTMF** tab, select **Sending Mode** to determine during which calls the DTMF signals can be sent.

5. Select the required DTMF sending methods.

**TIP**

Check that you have enabled the methods that are accepted by the device to be called.

6. Then set the DTMF methods that the device will receive on the **Receive DTMF** tab.
7. Save the changes.

User Sounds

The device performs several actions that are accompanied by sound (ringing, switching, etc.). You can change the sounds to be played in **Customization > User Sounds**.

Up to 10 custom user sounds can also be uploaded to the device.

Time Profiles

Some of the functions performed by the device are time dependent. The **Time Profiles** section allows you to preset time intervals and select them for these functions. This means you do not have to manually enter time whenever you set a time profile. You can name the time profile for better clarity.

Time Profile Creation:

1. Go to **Customization > Time Profiles**.
2. Click on empty to create a new profile.
3. Enter a profile name.
4. Click **Save**. The profile detail will open.
5. Set the intervals at which the time profile should be active.
 1. Click on the required interval.
 2. You can specify the profile start and end in an open menu.

**NOTE**

The **Holidays** line helps you set different time intervals during selected days, see [Holidays \(p. 42\)](#).

6. Save the changes.

Holidays

In the device configuration, you can define several days that will be marked as holidays. Special intervals are then set in the time profiles for these days. Typically, these are such days as public holidays, company holidays and other special days.

For each holiday, you specify whether it applies only to a particular year or whether it repeats on the same day each year. Holidays can be planned several years in advance.

Holiday Settings:

1. Go to **Customization > Time Profiles > Holidays**.
2. Select the year for which you want to set the holiday.
3. Click a day in the calendar:
 - The first click marks the holiday that will be repeated on the given day and month every year.
 - The second click changes the holiday to a one-time holiday for the selected year.
4. Save the changes.

Advanced SIP Account Settings

This section describes the optional features and SIP account parameters that are set in the **Calling > SIP** section.

The advanced SIP account settings allow you to increase security, optimize call quality and ensure compatibility with different PBXs. We recommend that only experienced administrators change the settings.

1. Go to **Calling > SIP** of the account to be set up.

SIP Functions

The REFER method allows for dynamic forwarding of active calls between various SIP identities, which provides a more flexible control of communication flows.

The PRACK method provides reliable acknowledgement of continuous call states between devices, which improves the communication quality and stability in SIP systems.

Media

Receive Only Encrypted Calls (SRTP) – allows you to receive SRTP-encrypted calls only. Unencrypted calls will be automatically rejected. At the same time, TLS is recommended as the SIP transport protocol for higher security.

Encrypted Outgoing Calls (SRTP) – set that outgoing calls shall be SRTP encrypted on this account. At the same time, TLS is recommended as the SIP transport protocol for higher security.

Adaptive Control of Video Quality – enable the use of extended RTP profile for feedback via the RTCP (RTP/AVPF). Enable the use of interactive video quality control according to RFC-4585 allowing for adaption of the video data flow to the currently available network connection quality.

Broadsoft Compatibility Mode – set the Broadsoft PBX compatibility mode. Having received re-invite from a PBX in this mode, the intercom replies by repeating the last sent SDP with currently used codecs instead of sending a complete offer.

Use MKI in SRTP Packets – enable the use of MKI (Master Key Identifier) if required by the counterparty for master key identification when multiple keys rotate in the SRTP packets.

Do Not Play Incoming Early Media – disable playing of the incoming audio stream before call pick-up, which is sent by some PBXs or other devices. A standard ringtone will be played instead.

Advanced Configuration

Sending KeepAlive Packets – set that the device shall send STUN/CRLF packets to the registrar on a regular basis and also SIP OPTIONS during calls to keep the setup connection active.

SRV Record Rotation – allow SRV record rotation for SIP Proxy and Registrar. It is an alternative method of transition to backup servers in the event of main server failure or unavailability.

IP Address Filter – enable the blocking of SIP packet receiving from addresses other than SIP Proxy and SIP Registrar. The primary purpose of the function is to enhance communication security and eliminate unauthorized phone calls.

Evaluating Older Backup Status -

QoS DSCP Value – set the SIP packet priority in the network. The set value is sent in the TOS (Type of Service) field in the IP packet header. Enter the value as a decimal number.

System

Date and Time Settings



CAUTION

If the device is managed by a bulk management tool (2N Access Commander / 2N My2N), the device time can be managed by this tool. Manual changes in the device web interface do not affect the time setting.

NTP Synchronization

If the device is connected to the Internet, the time and date values can be synchronized using NTP.

1. Go to **System > Date and Time**.
2. Activate the **Automatic Time from NTP or Internet** option on the **Time Synchronization Settings** tab.
3. Enter the address of the NTP server of your choice.

Time Update at Outage

1. Go to **System > Date and Time**.
2. Click **Sync with Browser** on the **Time Sync Settings** tab.
This synchronizes the device time with your PC time.



NOTE

The 2N devices are equipped with a real-time clock to back up the device for even a few days in case of power outage.

Network Configuration

By factory default, **2N Clip 2wire-IP** uses a dynamic IP address assigned by the DHCP server.

A proper IP address configuration is crucial for a stable and reliable connection of the device to your network.

1. Go to **System > Network Connection** to set the device network parameters.
2. You can enable/disable the DHCP server in Basic Settings > IP Address Settings.

Static IP Address Setting:

- a. Disable the **DHCP Server** option.
- b. Enter the desired IP address, subnet mask, default gateway and DNS servers.
- c. Save your changes. The device will be restarted.

DHCP Settings

- a. Enable the **DHCP Server** option.
- b. Enter the desired IP address, netmask, default gateway and DNS servers.
- c. Save your changes. The device will be restarted.

**NOTE**

If you use the RADIUS server and 802.1x-based verification of connected equipment, you can make the devices use the EAP-MD5 or EAP-TLS authentication. Set this function on the 802.1x tab.

Used Ports



Service	Port	Protocol	Direction	On by default	Configurable	Settings
802.1x	–	–	In/Out	×	×	–
DHCP	68	UDP	In/Out	✓	×	–
DNS	53	TCP/UDP	In/Out	✓	×	–
Echo (device discovery)*	8002	UDP	In/Out	✓	×	–
2N IP Eye	8003	UDP	Out	×	×	–
HTTP	80	TCP	In/Out	✓	✓	System > Network connection > WEB SERVER tab
HTTPS	443	TCP	In/Out	✓	✓	System > Network connection > WEB SERVER tab
NTP client	123	UDP	In/Out	✓	×	–
RTP+RTCP ports (SIP)	4900+ (range of 64 ports)	UDP	In/Out	×	✓	Calling > General Settings
RTSP client	554	UDP	In/Out	×	✓	–

Web configuration interface

Service	Port	Protocol	Direction	On by default	Configurable	Settings
SLP	427	UDP	In/Out	✓	×	–
SIP	5060, 5062	TCP/UDP	In/Out	×	✓	Calling > SIP
SIPS	5061	TCP	In/Out	×	✓	Calling >SIP
Syslog	514	UDP	Out	×	×	–
My2N Klocker	443	TCP	Out	✓	×	–
My2N Tribble Tunnel	443	TCP	Out	✓	×	–
Sitechannel (ICU protocol)	8004	UDP	In/Out	×	×	–
Multicast DNS	5353	UDP	In/Out	✓	×	–

Device Control

There are 3 buttons on the device front side for basic control of the device:





-  – the earphone button is primarily used for starting an outgoing and receiving/rejecting an incoming call,
-  – the lock button is primarily used for unlocking the set device,
-  – the speaker button is primarily used for the device volume control.





Button Functions

There are three types of a device button press:

- short press,
- long press,
- simultaneous long press of two buttons.

The device control options in the basic home screen display are as follows:

Button	Press type	Generated action
	Short press	Outgoing call to device A (see the note below for setting details).
	Long press	Outgoing call to device B (see the note below for setting details).
	Short press	Unlocking of device A lock (see the note below for setting details).
	Long press	Unlocking of device B lock (see the note below for setting details).
	Short press	Volume increase by one level (after the upper limit is reached, volume goes to the lowest value – value rotation) Upon a volume level change, the device plays the new volume level sound. The sound signaling is shown as a percentage on the display. The volume level is the same for all states and sounds. When the lowest volume level is selected (mute), the Mute signaling is displayed in all the states except for the Idle mode  .
	Long press	Ringtone Setting Menu (p. 52) is displayed.

Button	Press type	Generated action
 a 	Simultaneous long press of both buttons	Device Lock (p. 56) is activated. Enable the Device lock option in the Settings menu or in the web configuration interface.
 and 	Simultaneous long press of both buttons	Settings Menu (p. 50) is displayed.

**TIP**

To set up contacts for short-press (device A) or long-press (device B) calls, use the contact details in the Directory in the device web configuration interface.

The button control may be different in different operational states or menus of the device. Refer to the descriptions of the states and menus below for more information on the button actions:

- [Settings Menu \(p. 50\)](#),
- [Ringtone Setting Menu \(p. 52\)](#),
- [Calls \(p. 53\)](#),
- [Idle Mode \(p. 55\)](#),
- [Device Lock \(p. 56\)](#).

Home Screen

The Home screen is set as the start screen of the device, which is displayed whenever the device is activated by a or button press in the Idle mode. Its appearance depends on the device configuration, see below.

It is possible to activate the device lock from this state.

The device displays:

- Time

The home screen provides access to:

- Ringtone Setting Menu
- Directory
- Settings

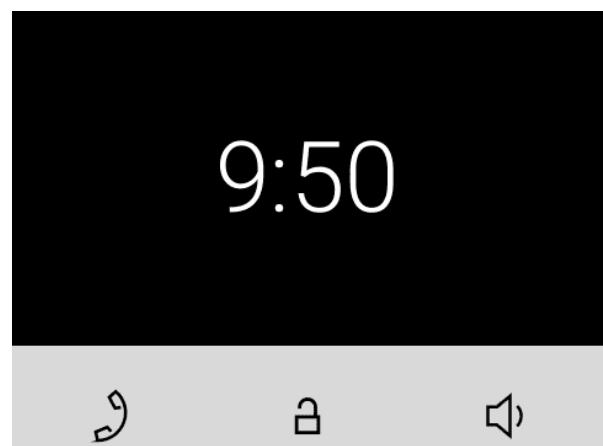

Possible actions	Performance	Action result
Display of Ringtone Setting Menu	Long Button Press 	Ringtone Setting Menu (p. 52) is displayed.
Settings Menu Display	Simultaneous long press of  and 	Settings Menu (p. 50) is displayed on the device.

Directory Menu

If 2 or more devices are added to **2N Clip 2wire-IP**, the Directory menu is displayed as introduction instead of the home screen. The Directory menu helps you display 2 devices – device A and device B. The displayed devices can be selected, see the note below. If there are more than 2 devices in the Directory or more than 2 are selected for display, they are arranged in the order and then alphabetically. If a group of devices is to be displayed, the name and icon of the first device on the list is used for display.

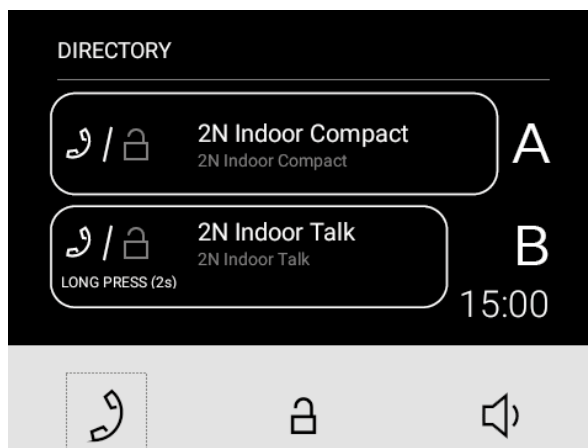

TIP

To set up contacts for short-press (device A) or long-press (device B) calls, use the contact details in the Directory in the device web configuration interface.







The Directory menu includes a list of added devices and available actions. If a call is missed from a displayed device, the missed call icon  appears at the respective device. The icon disappears when any action is performed from the home screen.

The Directory menu shows all the actions included in Subs. [Home Screen \(p. 48\)](#).





NOTE

If just 1 device is added, the Directory menu does not replace the introductory screen of the device. If a call is missed from a displayed device, the missed call icon  appears next to the time value. The icon disappears whenever an action is performed from the home screen.

Possible actions	Performance	Action result
Outgoing call to device A	Short press of 	Call to device A is started.
Outgoing call to device B	Long press 	Call to device B is started.
Device 1 Unlocking	Short press of 	The code of the unlock button short press is sent to open the device lock for which this code has been defined.
Device 2 Unlocking	Long press 	The code of the unlock button long press is sent to open the device lock for which this code has been defined.
Settings Menu Display		Settings Menu (p. 50) is displayed on the device.
Device lock activation	Simultaneous long press of  and 	Device Lock (p. 56) is activated.
Display of Ringtone Setting Menu	Long Button Press	Ringtone Setting Menu (p. 52) is displayed.

Settings Menu

After a long press of buttons  and , the home screen displays the Settings menu.

The Settings menu helps you set the device locally and contains a context menu in the bottom part, which is controlled using the device buttons.





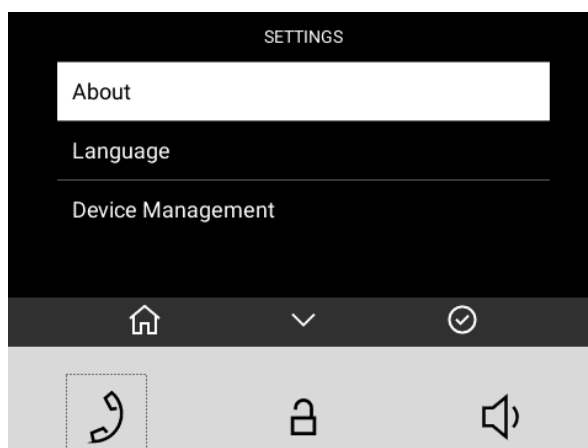

The Settings menu makes it possible to:

- display information on the device (firmware version, [IP address \(p. 25\)](#), etc.),
- change the device language,
- [restart the device \(p. 28\)](#),
- set the device display brightness,
- set the display inactivity timeout, i.e. the transition timeout for the device to switch into the [Idle mode \(p. 55\)](#),
- activate the [Device lock \(p. 56\)](#).



**NOTE**



Use the [Display](#) menu in the web configuration to block the access to the menu. At that moment, the device can be only be configured by software or remote access.

Possible actions	Performance	Action result
Return to home screen	by a short press of  , or in 10 seconds without any button being pressed, or after a call if any.	The selection is cancelled and the menu actions are terminated without saving.
Back (return to preceding action)	Short press of 	Navigation to the preceding menu section.
Selection confirmation	Short press of 	Confirmation of the selected setting option or transition to the selected menu section.
Move to next position	Short press of 	Movement by one position down in the setting. The movement is signaled with a white box highlighting the current position. When the list end is reached, the first position is moved onto.
Device restart confirmation	Short press of 	Device is restarted. The Home screen (p. 48) is displayed after restart.
<div data-bbox="762 1619 833 1686" data-label="Image"></div> <div data-bbox="869 1615 956 1646" data-label="Section-Header">NOTE</div> <div data-bbox="869 1648 1335 1718" data-label="Text"> <p>Restarting may take a rather long time after the button press.</p> </div>		
Quit device restart dialog	Short press of 	Navigation to the preceding menu section.

Ringtone Setting Menu

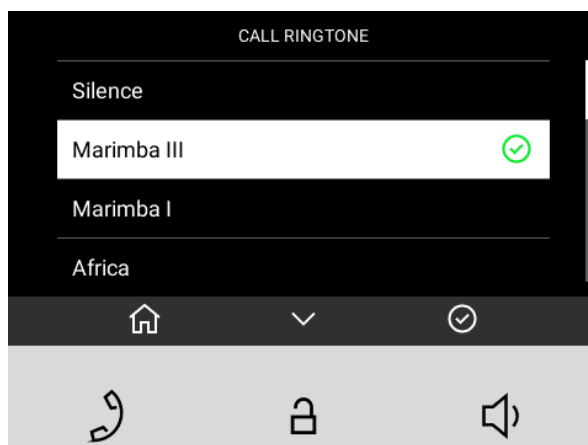
A long button press  displays the ringtone list.











Possible actions	Performance	Action result
Cancel the selection and return to the home screen.	Short press of 	The selection is cancelled and the menu actions are terminated without saving. Home screen (p. 48) is displayed.
Move to next ringtone	Short press of 	Movement by one position down in the setting. The movement is signaled with a white box highlighting the current position. When the list end is reached, the first position is moved onto. The selected ringtone position is white highlighted in the list. When the list end is reached, the first position is moved onto. Ringtone examples are played during the movement in the settings.
Selection confirmation	Short press of 	the selection is confirmed. The device sets the selected ringtone. Home screen (p. 48) is displayed.

Operational Statuses

This section includes a basic description of user scenarios and states that can occur during the use of **2N Clip 2wire-IP**, a list of user options in variable states and expected results of these actions.

Signaling of Operational Statuses

The device generates sounds to signal changes of and switching between operational statuses. Each status change is assigned a different type of tone. See the table below for the list of signals.

Sound signaling	State
	<p>Internal application started</p> <p>The internal application is launched after the power supply is turned on or the device is restarted.</p>
	<p>Connected to the LAN, IP address received</p> <p>Once the internal application is started, the device logs in to the LAN.</p>
	<p>Disconnected from the LAN, IP address lost.</p> <p>Disconnected from the LAN, IP address lost</p>
	<p>Invalid phone number or invalid switch activation code</p> <p>The device allows you to enter the door opening code. This tone signals that invalid values have been entered.</p>
	<p>Reset of network parameters</p> <p>Upon power up, the network parameters can be changed by hardware, refer to Configuration via Hardware (p. 29).</p>
	<p>Approaching call end signaling</p> <p>The device allows you to set a call end timeout, Calling > General settings > Call time limit.</p>
	<p>Call extension confirmation signaling</p> <p>A call can be extended by pressing a key on the VoIP phone.</p>
	<p>Connected call from a VoIP phone to the device</p> <p>A short tone is played to signal that the VoIP call has been connected to the device.</p>

Calls

In this state, connection or connection attempt is in progress with another device. The **2N Clip 2wire-IP** functions are limited, it is impossible to switch to the home page and go to menus. Possible actions are included in the table below.

A preview of the camera if available is shown on the display.

In this state, one of the following call types can be active in the device:

- **Outgoing call** initiated by the **2N Clip 2wire-IP** answering unit.
- **Incoming** trying to establish connection with the **2N Clip 2wire-IP** answering unit.
- **Active call** – if connection between the devices is established, sound is transmitted.

Outgoing Call

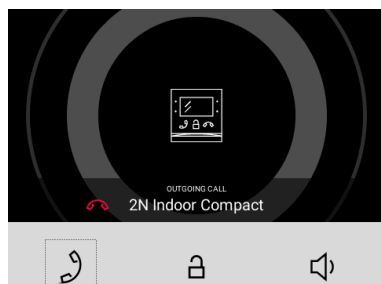



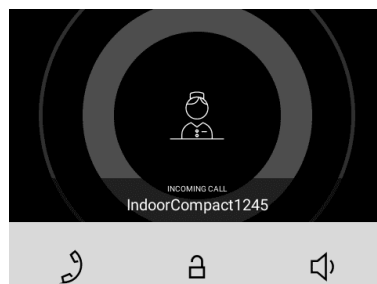

Incoming Call

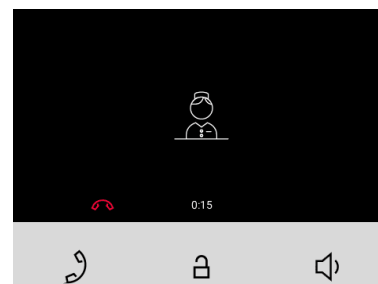

Active Call



Possible actions	Performance	Action result
Incoming call receiving		<p>Connection with the other device has been established, a call is in progress.</p> <p>The call cannot be ended until answered.</p>
End of call		<p>The active call is interrupted.</p> <p>The call cannot be ended until answered.</p>
Target device lock opening		<p>A specifically configured unlock code is sent to the target device and, if the code is compatible with the device, the target device lock opens. If no unlock code is set, the default unlock code is sent to the target device.</p> <p>During a call, the unlock button sends a code after a long press, if set.</p> <p>Door unlocking is signaled by a tone and green flash of the lock button.</p>
Call volume control		<p>Volume increase by one level (after the upper limit is reached, volume goes to the lowest value – value rotation)</p>



Possible actions	Performance	Action result
Ringtone Disable		<p>The ringtone stops playing when a call comes in. The incoming call is not ended.</p> <p>The repress of the button does not cancel mute.</p>

Idle Mode

2N Clip 2wire-IP transits into the Idle mode after a set inactivity period. You can determine the length of this period in **Customization > Backlight** in the web configuration or using device control in [Settings Menu \(p. 50\)](#). The operation power consumption is reduced in the Idle mode.

The device shows no information on the display in the Idle mode.

[At Relax \(p. 55\)](#):

- If only 1 device is added to the directory, the code after a long press will be sent whenever the unlock button is pressed .
- If 2 devices are added to the directory, the code after a short press will be sent whenever the unlock button is pressed .







Possible actions	Performance	Action result
Idle mode end	Press any key	The device quits the Idle mode. The Directory Menu , Home Screen (p. 48) or Device Lock (p. 56) is displayed.

Device Lock

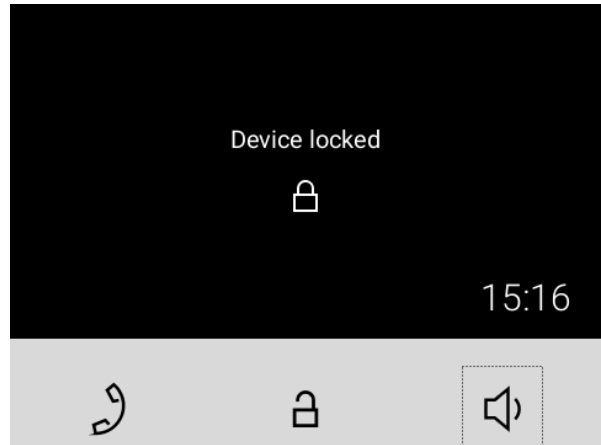
Enable the Device lock option in the Settings menu or in the web configuration interface.

When the lock is activated, the device rings to signal an incoming call and displays the caller identification including the camera preview if available. The call cannot be received until the device lock is deactivated.



Possible actions	Performance	Action result
Device lock activation	Simultaneous press of  and  for 3 seconds	The lock is activated.
Device lock deactivation	Simultaneous press of  and  for 3 seconds	The device is unlocked and you can go to other operational statuses and perform other actions.

Maintenance - Cleaning

2N Clip 2wire-IP contains no environmentally harmful components. Dispose of the device in accordance with the applicable legal regulations.

If used frequently, the device surface gets dirty. Use a piece of soft cloth moistened with clean water to clean the device. Use appropriate cleaning agents suitable for glasses, optical devices, screens, etc. We recommend that IT cleaning wipes are used.



CAUTION

Use the product for the purposes it was designed and manufactured for, in compliance herewith. The manufacturer reserves the right to modify the product in order to improve its qualities.

If used frequently, the device surface gets dirty. Use a piece of soft cloth moistened with clean water to clean the device. Use appropriate cleaning agents suitable for glasses, optical devices, screens, etc. We recommend that IT cleaning wipes are used.

Troubleshooting

Refer to <https://www.2n.com/faqs> for the most frequently solved problems.

Technical Parameters

2N Clip 2wire-IP

Power Consumption	
Stand-by mode with display off	1,2 W
Stand-by mode with display on	2.0 W
Calls without audio	2.4 W
Calls with audio	4.4 W
Calls with induction loop	6.4 W

User interface	
Controls	3 capacitive buttons
Display	4" with 480 x 272 pixel resolution

Signaling protocol	
SIP	UDP, TCP, TLS

Audio	
Microphone	integrated
Speaker	3 W integrated

Technical Parameters

Audio

Induction loop output

NO (induction loop integration depends on the model version)

Audio stream

Protocols

RTP

Codecs

PCMU, PCMA, G.729, G.722, L16/16kHz

Video stream

Protocols

RTP, RTSP, HTTP

Codecs

H.264

Video Resolution

480 x 272 px

Frame rate

up to 15 frames per s

Interface

2 wires 10 Mbit

2N 2 wire-IP 10 Mbit, recommended single core 24AWG, cat3 cable

Doorbell input

Input type

Switching contact (button/relay)

Contact type

Normally open (NO)

Technical Parameters

Doorbell input

Contact parameters

Min. 12 V / 20 mA, DC

Mechanical Parameters

Device dimensions (W x H x D) 124 x 150 x 26 mm

Weight Main unit 295 g

Operating temperature 0 to 50 °C

Relative humidity 10 to 90 % non-condensing

Storing temperature -20 °C to 70 °C

Recommended altitude up to 2000 m

2N Clip 2wire-IP Switch

Power supply

Power supply 48 V DC, the cable length between the switch and the power supply must not exceed 3 m (installation)

Limited Power Source (LPS) 1.92 A LPS

Technical Parameters

Interface

LAN for connecting two IP devices, the first position provides PoE (IEEE 802.3af) functionality

100Base-TX, RJ45, LAN1 PoE

recommended cable type: min. Cat 5e shielded 24AWG

2N 2Wire-IP interface (TWO WIRE INTERFACE)

↓ 100 Mbps input/output Leader

↑ 100 Mbps input/output Follower

designed for connection to another 2wire switch

1-6 10 Mbps output (POWER OUTPUTS)

designed for connecting an answering unit (typically 48 V DC / max guaranteed continuous output current of 200 mA (short-circuit protection) / it is recommended that a device with continuous power consumption of max 10 W is connected)

recommended cable type: min. Cat 3 single pair, 24AWG

USB

service connector intended exclusively for the manufacturer's service purposes

Mechanical Parameters

Device dimensions (W x H x D) 157 x 58.5 x 102 mm (with terminals mounted)

Operating temperature -10 °C to +55 °C

Recommended altitude 0 to 2000 m

Mounting DIN rail for electrical switchboard with protective cover

General Instructions and Cautions

Please read this User Manual carefully before using the product and follow the instructions and recommendations included therein.

Any use of the product that is in contradiction with the instructions provided herein may result in malfunction, damage or destruction of the product.

The manufacturer shall not be liable and responsible for any damage incurred as a result of a use of the product other than that included herein, namely undue application and disobedience of the recommendations and warnings.

Any use or connection of the product other than those included herein shall be considered undue and the manufacturer shall not be liable for any consequences arisen as a result of such misconduct.

Moreover, the manufacturer shall not be liable for any damage or destruction of the product incurred as a result of misplacement, incompetent installation and/or undue operation and use of the product in contradiction herewith.

The manufacturer assumes no responsibility for any malfunction, damage or destruction of the product caused by incompetent replacement of parts or due to the use of reproduction parts or components.

The manufacturer shall not be liable and responsible for any loss or damage incurred as a result of a natural disaster or any other unfavorable natural condition.

The manufacturer shall not be held liable for any damage of the product arising during the shipping thereof.

The manufacturer shall not make any warrant with regard to data loss or damage.

The manufacturer shall not be liable and responsible for any direct or indirect damage incurred as a result of a use of the product in contradiction herewith or a failure of the product due to a use in contradiction herewith.

All applicable legal regulations concerning the product installation and use as well as provisions of technical standards on electric installations have to be obeyed. The manufacturer shall not be liable and responsible for damage or destruction of the product or damage incurred by the consumer in case the product is used and handled contrary to the said regulations and provisions.

The consumer shall, at its own expense, procure software protection of the product. The manufacturer shall not be held liable for any damage incurred as a result of the use of deficient security software.

The consumer shall, without delay, change the access password for the product after installation. The manufacturer shall not be held liable or responsible for any damage incurred in connection with the use of the original password.

The manufacturer also assumes no responsibility for additional costs incurred by the consumer as a result of making calls to increased tariff lines.

Directives, Laws and Regulations

2N Clip 2wire-IP conforms to the following directives and regulations:

EU

- 2012/19/EU on waste electrical and electronic equipment

- 2014/30/EU for electromagnetic compatibility
- 2014/35/EU for electrical equipment designed for use within certain voltage limits
- 2011/65/EU on the restriction of the use of certain hazardous substances in electrical and electronic equipment

Industry Canada

This Class B digital apparatus complies with Canadian ICES-003/NMB-003.

Electric Waste and Used Battery Pack Handling



Do not place used electric devices and battery packs into municipal waste containers. An undue disposal thereof might impair the environment!

Deliver your expired household electric appliances and battery packs removed from them to dedicated dumpsites or containers or give them back to the dealer or manufacturer for environmental-friendly disposal. The dealer or manufacturer shall take the product back free of charge and without requiring another purchase. Make sure that the devices to be disposed of are complete.

Do not throw battery packs into fire. Battery packs may not be taken into parts or short-circuited either.



2N Clip 2wire-IP – User Manual

© 2N Telekomunikace a. s., 2026

2N.com