



# 2N Indoor View Wi-Fi

User Manual



# Table of Contents

<b>Symbols and Terms Used</b> .....	<b>4</b>
<b>Product Description</b> .....	<b>5</b>
Basic Features .....	5
Product Versions .....	6
Accessories for Installation .....	6
Package Completeness Check .....	7
Component Layout .....	8
<b>Mechanical Installation</b> .....	<b>9</b>
Installation Conditions .....	9
Wall Installation .....	9
Flush Mounting .....	10
Wall Mounting Box Installation for Device Wall Mounting .....	12
Stand Installation .....	13
Power Supply .....	14
PoE Supply Connection .....	15
External Power Supply .....	16
Tactile stickers .....	16
<b>Brief Guidelines</b> .....	<b>17</b>
IP Address Retrieval .....	17
IP Address Retrieval Using 2N IP Utility .....	17
IP Address Retrieval using Device Display .....	18
IP Address Retrieval Using the RESET button .....	19
Wi-Fi Connection .....	20
Access to web device configuration .....	20
Password Change .....	21
Recommended browsers .....	21
Firmware Update .....	21
Device Restart .....	22
Restart Using Web Configuration Interface .....	22
Restart Using Device Buttons .....	22
Restart Using RESET Button .....	23
Factory Default Reset .....	23
Factory Default Reset via Web Configuration Interface .....	23
Factory Default Reset with RESET Button .....	23
Configuration via Hardware .....	23
Device Restart .....	24
IP Address Retrieval Using the RESET button .....	24
Static IP Address Setting with RESET Button .....	25
Dynamic IP Address Setting via RESET .....	25
Factory Default Reset with RESET Button .....	26
<b>Web configuration interface</b> .....	<b>27</b>
First Login .....	27
Finding devices in the network .....	27
Access to web device configuration .....	31
Basic Device Settings .....	32
Firmware Update .....	32
Directory .....	33
Calling .....	33
Display Settings .....	36
Advanced Settings .....	36
Sound Settings .....	36
Time Profiles .....	37
Advanced SIP Account Settings .....	38

System .....	39
Date and Time Settings .....	39
Network Configuration .....	39
Used Ports .....	40
<b>Device Control .....</b>	<b>42</b>
Configuration via Hardware .....	43
Device Restart .....	44
IP Address Retrieval Using the RESET button .....	44
Static IP Address Setting with RESET Button .....	45
Dynamic IP Address Setting via RESET .....	45
Factory Default Reset with RESET Button .....	46
Icons used on the display .....	46
Home Screen .....	49
Directory Menu .....	50
Call Log .....	52
Settings .....	53
Control Center .....	58
Hotel Mode .....	59
Operational Statuses .....	61
Signaling of Operational Statuses .....	61
Calls .....	62
Idle Mode .....	64
Device Lock (Screen Lock) .....	65
Do Not Disturb Mode .....	66
<b>Maintenance - Cleaning .....</b>	<b>67</b>
<b>Troubleshooting .....</b>	<b>68</b>
<b>Technical Parameters .....</b>	<b>69</b>
<b>2N Indoor View Wi-Fi .....</b>	<b>69</b>
<b>General Instructions and Cautions .....</b>	<b>72</b>
Directives, Laws and Regulations .....	72
EU .....	72
Industry Canada .....	73
Electric Waste and Used Battery Pack Handling .....	73

## Symbols and Terms Used

The following symbols and pictograms are used in the manual:



**DANGER**

**Always abide** by this information to prevent persons from injury.



**WARNING**

**Always abide** by this information to prevent damage to the device.



**CAUTION**

**Important information** for system functionality.



**TIP**

**Useful information** for quick and efficient functionality.



**NOTE**

Routines or advice for efficient use of the device.

# Product Description

In this section, we introduce the **2N Indoor View Wi-Fi** product, outline its application options and highlight the advantages following from its use.

## Basic Features

**2N Indoor View Wi-Fi** is an internal IP/SIP unit providing audio and video communication with the 2N IP intercoms.

The device includes a touch panel on 3 mm thick tempered glass, a loudspeaker, a high-quality microphone for excellent audibility and clarity, an Ethernet interface and a Wi-Fi interface for connecting to the LAN, and connectors for connecting an external power supply and a doorbell connector.

The device includes a touch panel on 3 mm thick tempered glass, a loudspeaker, a high-quality microphone for excellent audibility and clarity, an Ethernet interface and a Wi-Fi interface for connecting to the LAN, and connectors for connecting an external power supply and a doorbell connector.

**2N Indoor View Wi-Fi** is equipped with a specific user interface for an increased user comfort while configuring the device.

Basic Features **2N Indoor View Wi-Fi**:

- 7" color LCD video display
- full duplex handsfree HD audio communication
- Wi-Fi interface for wireless LAN connection
- easy flush mounting
- remote administration and configuration via **2N Remote Configuration**
- call setup option via **My2N app** on a smartphone
- Do Not Disturb Mode
- device lock
- remote door lock control
- time display
- current weather display
- integrated administrator web interface
- external power supply input
- induction loop output
- external doorbell button input.

## Product Description

### Complex solution connection diagram

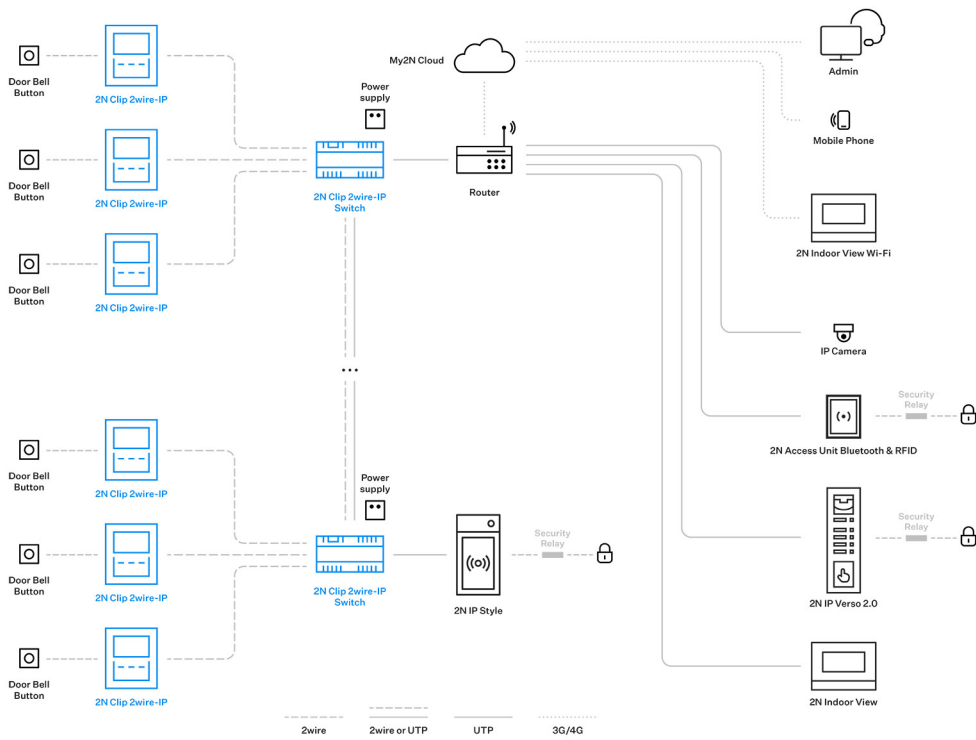

### Product Versions



**Part No.: 91378611WH**

Axis Part No. 03135-001

**2N Indoor View Wi-Fi**

White version



**Part No.: 91378611**

Axis Part No. 03134-001

**2N Indoor View Wi-Fi**

Black version

### Accessories for Installation

Choose the proper accessories for your particular installation needs.

## Product Description

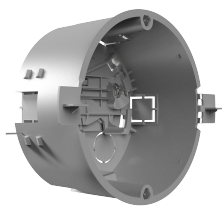

**Part No. 91378800**

Axis Part No. 01700-001

Mounting box

Wall/plasterboard flush mounting box for 2N indoor answering units.

---



**Part No. 91378803**

Axis Part No. 02320-001

Wall mounting box

Wall surface mounting box for 2N indoor answering units.

---

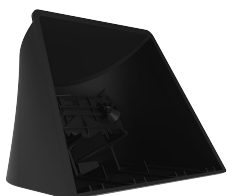

**Part No. 91378802**

Axis Part No. 02039-001

Stand

Stand for 2N indoor answering units.

## Package Completeness Check

Please check the product delivery before installation. Contents:

1x	<b>2N Indoor View Wi-Fi</b>
2x	External power and doorbell button terminals
1x	Certificate of ownership
1x	2.5 mm hexagon key wrench
1x	Quick Start manual
1x	Display cleaning cloth
2x	Tactile sticker

## Component Layout

### Front

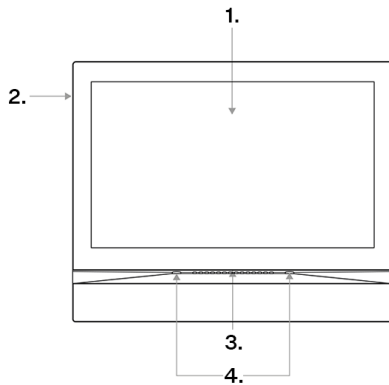

1. Display
2. Microphone
3. Speaker
4. Anchoring holes

### Rear

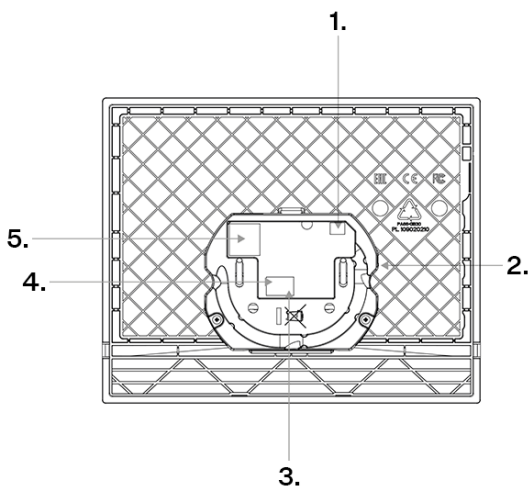

1. External induction loop output
2. RESET Button
3. Doorbell button input
4. 12 V / 1 A DC power supply input
5. Ethernet

# Mechanical Installation

This subsection provides the **2N Indoor View Wi-Fi** installation and connection instructions.

The device can be installed on any of the following ways:

- into a wall using a mounting box (not included in the package),
- onto a wall using a mounting box (not included in the package),
- into a stand (not included in the package).

## Installation Conditions



### CAUTION

The device mounting and setting should only be performed by professionally qualified persons.

- Exceeding the allowed operating temperature may not affect the device immediately but leads to premature ageing and lower reliability. For the acceptable range of operating temperatures and relative humidity values refer to S. [Technical Parameters \(p. 69\)](#).
- Keep some free space above and below the device to allow air to flow and conduct heat away.
- No strong electromagnetic radiance is allowed on the installation site.
- Make sure that the VoIP connection is configured properly according to the SIP and other VoIP recommendations.
- It is recommended that the power adapter be connected to the mains via a UPS and reliable overvoltage protection.
- The device is designed for vertical wall mounting (perpendicular to the floor) in the approximate height of 120 cm above the floor. If necessary, operate the device in a position other than as aforementioned for a short time only, for quick testing purposes in a servicing center, for example.



### WARNING

This device must be deployed within a network infrastructure that provides adequate protection against Denial-of-Service (DoS) attacks and similar network-based threats. The device does not include built-in protection against high-volume or malicious traffic and relies on the surrounding network environment—such as firewalls, intrusion prevention systems, or rate limiting—for defense. Failure to implement appropriate network security measures may lead to service degradation or unavailability. The equipment's user documentation shall contain a [description of all exposed network interfaces and all services exposed via network interfaces](#), which are delivered as part of the factory default state.

## Wall Installation

**2N Indoor View Wi-Fi** is designed for flush mounting (brick, plasterboard, wood). Use the flush mounting box (Part No. 91378800), which is not included in the package. Alternatively, the product can be surface installed in a wall box (Part No. 91378803) or mounted into a desk stand (Part No. 91378802).

- [Flush Mounting \(p. 10\)](#)  
Flush mounting using a walled-in mounting box

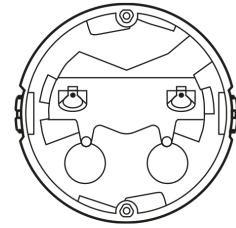

- [Wall Mounting Box Installation for Device Wall Mounting \(p. 12\)](#)  
On-wall mounting using a wall surface mounting box

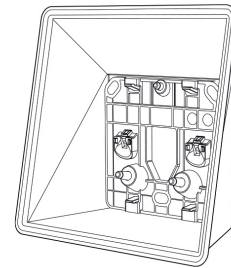

### Flush Mounting

1. [Flush Mounting Box Installation \(p. 10\)](#)
2. [Flush Mounting Box Device Installation \(p. 11\)](#)

### Flush Mounting Box Installation



#### CAUTION

Before starting the mechanical installation on a selected place, make sure carefully that the preparations associated with it (drilling, wall cutting) cannot damage the electrical, gas, water and other existing wires and pipes.



#### TIP

Download the [Drilling template](#) from [2N.com](#) .

1.

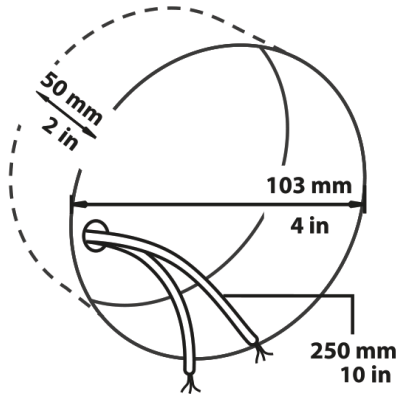

2a.

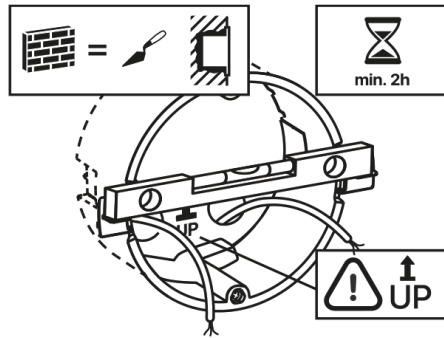

2b.

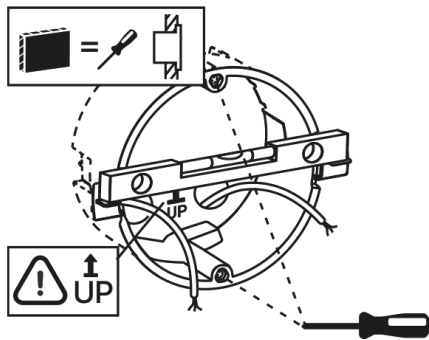

3.

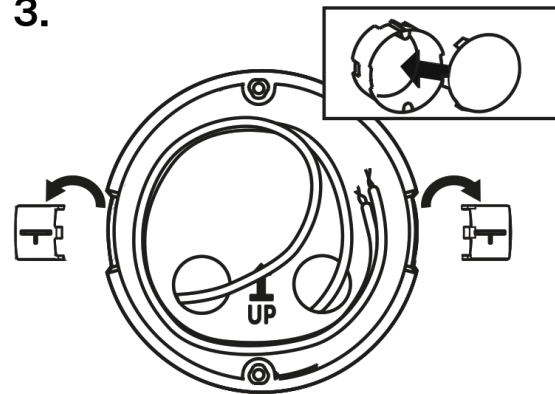

1. Cut a circular hole in the wall of the diameter of 103 mm and depth of 50 mm before installation. It is assumed that all necessary cables of the maximum length of 25 cm will lead to the hole.
2. Put the flush mounting box in the hole to make sure that the hole is deep enough.
3. If the hole complies with the box size, wall in the box and level the box using a water level on the holding clips.
4. When the mortar hardens, break off the clips and cap the box with the cover provided. Use anchoring elements to fix the device into plasterboard.

To install **2N Indoor View Wi-Fi** into a flush mounting box, get a 2.5 mm hexagon key wrench, which is included in the package.



**NOTE**

When installing **2N Indoor View Wi-Fi** into a wall, take the local standards related to installation of electrical devices on flammable material into consideration.

**Flush Mounting Box Device Installation**



**TIP**

Refer to Subs. [Component Layout \(p. 8\)](#) for connector layout.

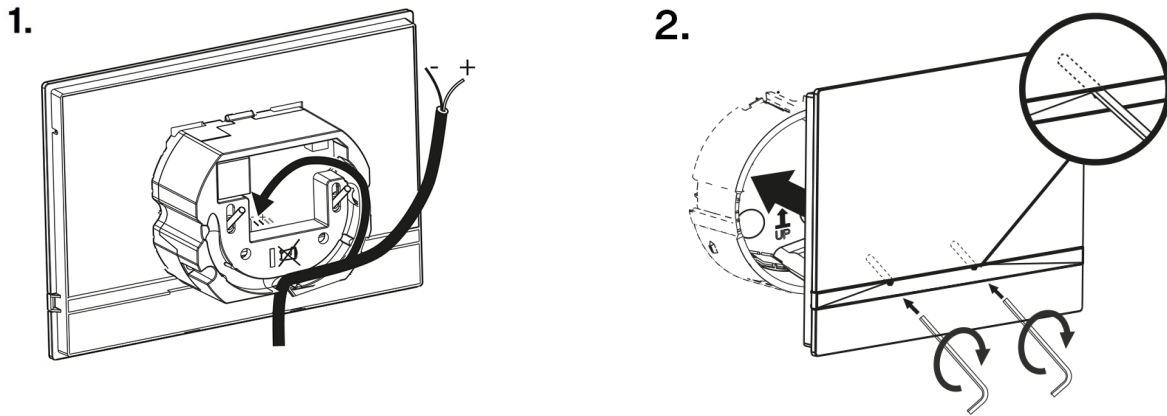

1. Remove the cover from the wall-mounted installation box. Take out the pre-prepared cabling, the UTP cable the bell wire (two-wire), power supply.
2. Shorten the cables to 150 mm or less as required. Connect the doorbell twin cable or power supply cable to the connector provided.
3. For connection via Ethernet.  
Crimp the RJ-45 connector onto the UTP cable.
4. Take the device and lean its bottom edge against the wall below the flush mounting box.
5. First connect the green power supply/doorbell connector to the device.  
For connection via Ethernet.  
Connect the LAN connector.
6. Put the cables carefully in the pre-drilled back slot of the device to prevent them from blocking any horizontal levelling movement during the final installation stage.
7. Insert the device in the flush mounting box making sure that it clicks onto the centering pins. The pins allow for a 5–6 ° inclination on either side for accurate horizontal levelling of the device.  
Now the device is ready for basic operation. It is necessary to perform [software configuration](#) to achieve a full functionality of the device.

### Wall Mounting Box Installation for Device Wall Mounting

**2N Indoor View Wi-Fi** can be installed using a wall mounting box. The device display slope is 12% in this type of installation. Use the mounting box (Part No. 91378803), which is not included in the package.



#### TIP

- Download the [drilling template](#) from 2N.com.
- Refer to Subs. [Component Layout \(p. 8\)](#) for connector layout.

1.

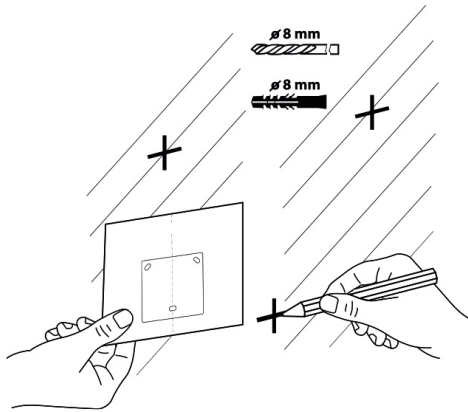

2.

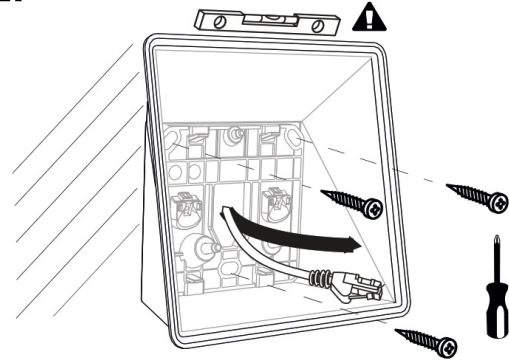

3.

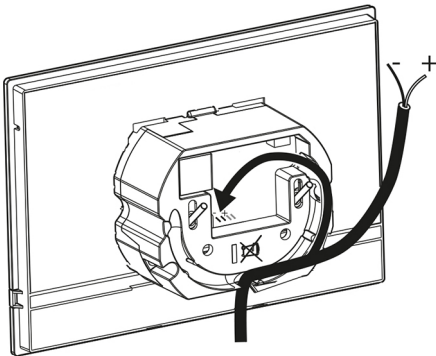

4.

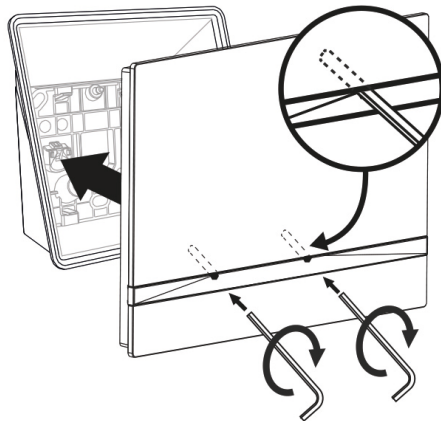

1. Drill holes of the diameter of 8 mm for the dowels and screws (included in the package). It is assumed that all the necessary cables of the maximum length of 25 cm will lead to the place.
2. Fit the wall mounting box into the predrilled holes. Pull the available cables through the box opening. Use a water level for a more precise levelling.
3. First connect the green power supply/doorbell connector to the device.  
For connection via Ethernet.  
Connect the LAN connector.
4. Put the cables carefully in the pre-drilled back slot of the device to prevent them from blocking any horizontal levelling movement during the final installation stage.
5. Fit the device screws into the nuts in the box with the hexagon key wrench provided.  
Now the device is ready for basic operation. It is necessary to perform [software configuration](#) to achieve a full functionality of the device.

## Stand Installation

Within installation preparations, take out the pre-prepared cabling, UTP cable, doorbell (twin) cable and power supply. Shorten the cables as required. Crimp the RJ-45 connector onto the UTP cable. Connect the doorbell twin cable or power supply into the connector.



### TIP

Refer to Subs. [Component Layout \(p. 8\)](#) for connector layout.

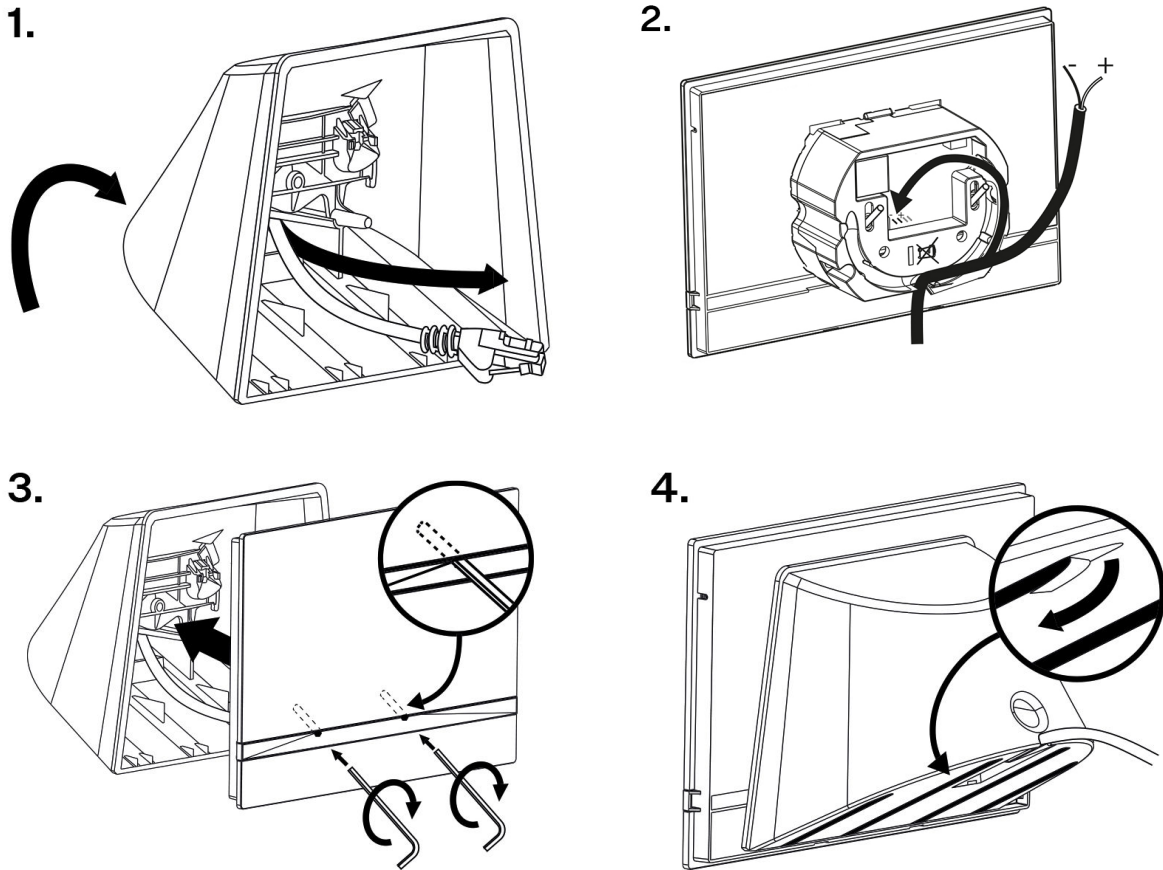

1. Pull the cables through the hole in the stand bottom.
2. First connect the green power supply/doorbell connector to the device.  
For connection via Ethernet.  
Connect the LAN connector.
3. Put the cables carefully in the pre-drilled back slot of the device to prevent them from blocking any horizontal levelling movement during the final installation stage.
4. Put the device on the stand making sure that it fits onto the centering pins. The alignment of the stand bottom edge and the device bottom strip means that the device is installed properly. Fit the device to the stand by tightening the screws through the front side. Use a hexagon key wrench for tightening. Tighten the screws gently.
5. Remove the protective foil from the antislip belts on the stand bottom and install the device on a selected place.  
Now the device is ready for basic operation. It is necessary to perform [software configuration](#) to achieve a full functionality of the device.

## Power Supply

**Power supply must comply with PS1 class output.**

You can feed **2N Indoor View Wi-Fi** as follows:

1. Using a 12 V / 1 A DC power adapter connected to the backside terminal board.
2. Use an Ethernet cable connected to a PoE supply or PoE supporting Ethernet switch/router.

It is recommended that the power adapter be connected to the mains via a UPS and reliable overvoltage protection.

**2N Indoor View Wi-Fi** Consumption Table:

Supply type	Consumption	Polarity reversal protection
PoE, IEEE 802.3af (recommended)	12 W	✓
12 V DC $\pm 10\%$ adapter; 1 A	12 W	✓

Each 2N Clip 2wire-IP switch is powered by an external power supply. We recommend using the Mean Well HDR-100-48 (1120302, 03479-001) rated at 48 V DC, 1.92 A.

### Technical Parameters



#### CAUTION

This device cannot be connected directly to telecom lines (or public wireless networks) of any telecom service providers (i.e. mobile providers, landline providers or Internet providers). A router has to be used for the device Internet connection.



#### WARNING

- Connection of a defective or improper power supply may lead to a temporary or permanent device failure.
- If you use a power adapter other than the recommended one, do not exceed the 12 V rated supply voltage. Also check the supply voltage polarity. Higher voltage values or misconnections may result in an irreplaceable device damage.

## PoE Supply Connection

Use a standard straight RJ-45 terminated cable to connect **2N Indoor View Wi-Fi** to the Ethernet. The device supports the 10BaseT and 100BaseT protocols.



#### CAUTION

- Factory reset results in a change of the Ethernet interface configuration.
- A defective Ethernet cable may lead to a high packet loss in the Ethernet and subsequent instability and poor call quality.

### Ethernet cable connector

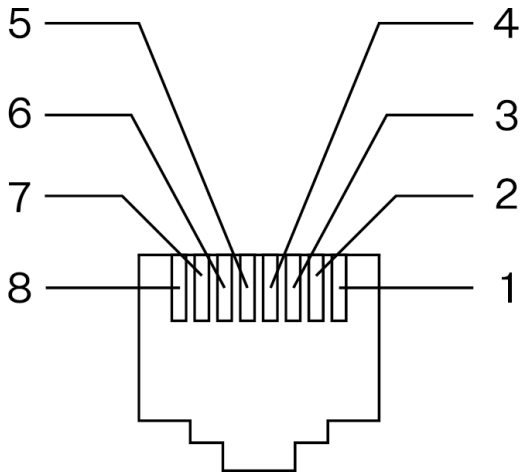

### Ethernet socket

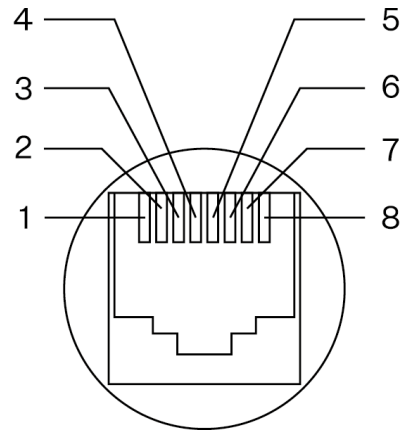

1. Tx+
2. Tx-
3. Rx+
4. unused
5. unused
6. Rx-
7. unused
8. unused

## External Power Supply



### CAUTION

- Make sure that the external power supply meets the power supply class 2 (PS2/LPS) .
- Make sure that the wires are firmly attached to the terminal to avoid any free contact.

The **2N Indoor View Wi-Fi** main unit package includes a removable terminal, which provides connection to the main unit backside connectors.

### Adapter Connection (1341481, 02520-001)

The white wire at the end of the adapter carries the positive charge (+), the black wire carries the negative charge (-).

## Tactile stickers

Special tactile stickers with raised surfaces are included in the package. These stickers help people with visual impairments to recognize the basic controls of the device.

We recommend placing the sticker next to the incoming call receiving button.



### NOTE

Clean the device surface from dust and dirt before applying the sticker.

# Brief Guidelines

## IP Address Retrieval

To retrieve the device IP address, take the following steps:

- Use the freely accessible 2N IP Utility.
- Display information on the device display.
- Use hardware (RESET button).

### IP Address Retrieval Using 2N IP Utility

The 2N IP Utility application helps find the 2N device IP address in the LAN. Download 2N IP Utility from the [2N.com](https://www.2n.com) website. Make sure that Microsoft .NET Framework 4.7.2 is installed for successful app installation.

1. Run the 2N IP Utility installer.
2. The Installation Wizard will help you with the installation.
3. Having installed 2N IP Utility, start the application using the Microsoft Windows Start menu. Once started, the application begins to automatically search the LAN for all the 2N and AXIS devices which have been DHCP/statically assigned IP addresses. These devices are then shown in a table.

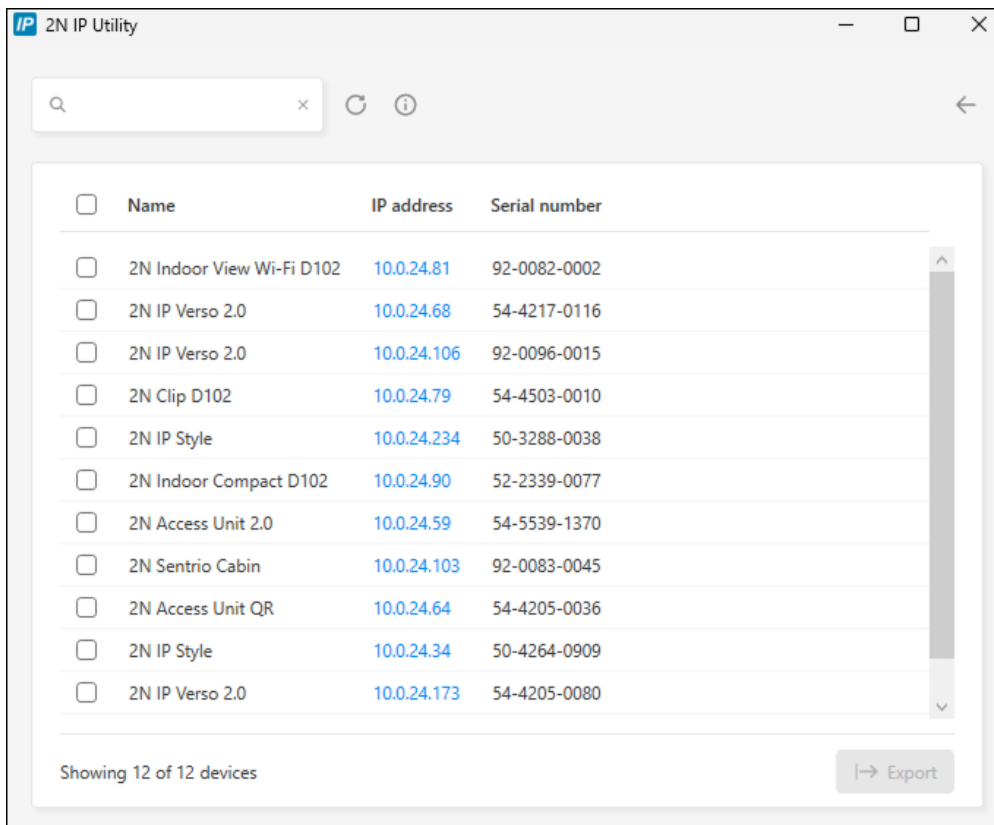

4. Select the device to be configured and left-click it. This opens the right-hand part of the web configuration interface window.



**TIP**

- Access to the web configuration interface is also possible via the **Open in external browser** button, which opens the interface in a separate browser window.
- Click a device in the list to display detailed information. Click the **IP settings** button to change the IP address by entering the required static IP address or activating DHCP.
- The application also allows you to export selected devices into a CSV file. First select a device by ticking the boxes in the list, then use the **Export** button that appears at the bottom of the window. The exported file shall include the names, IP addresses and serial numbers of the selected devices.

The default login data are:

Username: **Admin**

Password: **2n**

It is necessary to change the password immediately upon the first login.



**TIP**

It is recommended that a password is used that is difficult to break. It is not recommended that names, places or things, especially those closely related to the user, are used in the password.

For increased password security, it is recommended that:

- the random password generator is used,
- the password length is 12 characters at least,
- various characters from different character sets are combined (small/capital letters, digits, special characters, etc.).

## IP Address Retrieval using Device Display

To find the device IP address on the device, click any display spot to quit the Idle mode. The [Settings menu](#) is displayed on the Home screen after press of the setting icon  in the right-hand bottom corner buttons. Find the IP address information in About device.

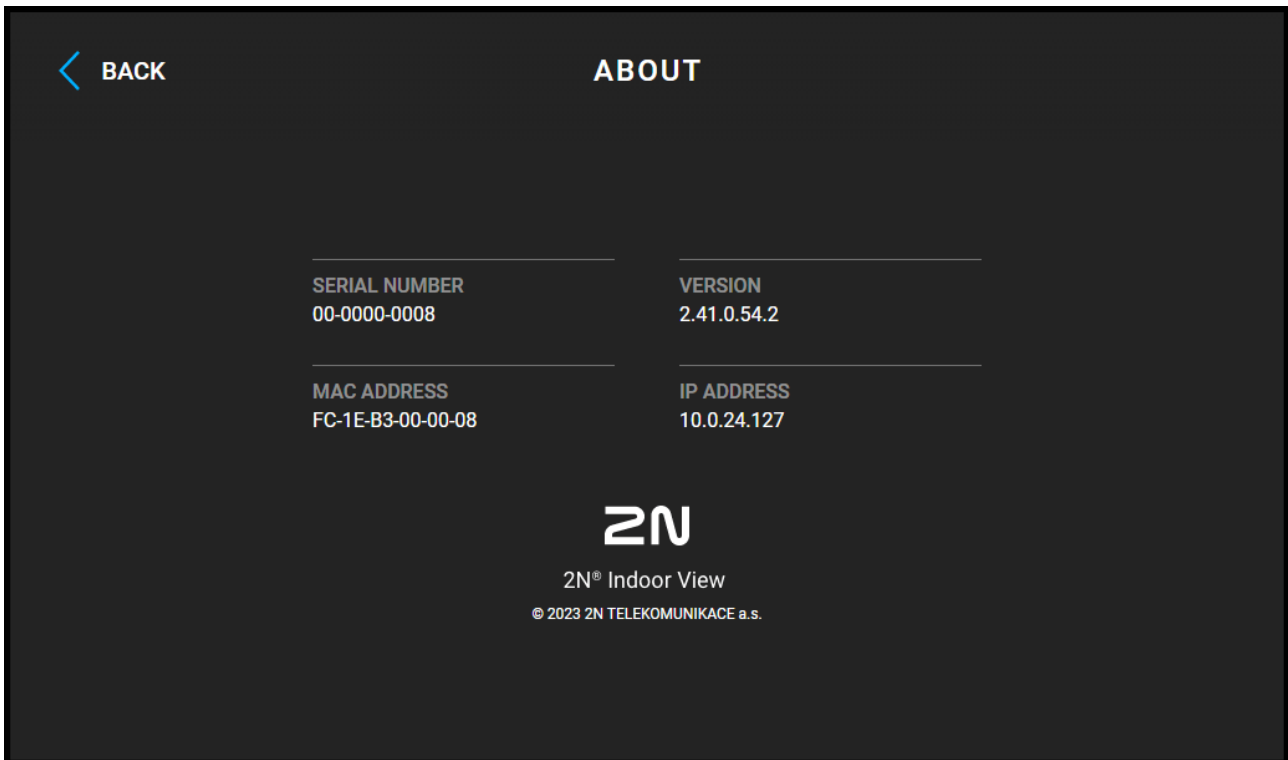

## IP Address Retrieval Using the RESET button

Follow the instructions below to retrieve the current IP address:

1. Press the button RESET and keep it pressed.
  - a. Wait until the red and green LEDs go on simultaneously on the device and the acoustic signal can be heard 🗣️ (approx. 15–35 s).
2. Release the RESET button.
3. The device announces the current IP address via the speaker automatically.

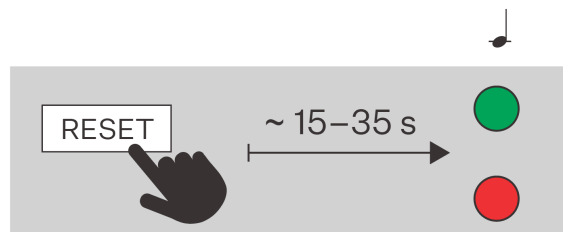

### NOTE

The delay after pressing RESET till the first light and sound signaling is set to 15–35 s depending on the device model used.

## Wi-Fi Connection

**2N Indoor View Wi-Fi** supports two network connection methods: wireless Wi-Fi or Ethernet cable. These methods cannot active at the same time. Upon the first start (factory default), set the Wi-Fi connection directly on the device using the display.

### Wi-Fi Connection via Display

1. From the Home screen go to Settings > Advanced settings.



#### NOTE

The Advanced settings are available without a code in the factory default configuration. Having changed the default web configuration interface login password, you have to enter an access code. Set the Advanced settings access code in the web configuration interface (Hardware > Display > Advanced settings code > Advanced settings code).

2. Go to **Network settings > Connection type**.
3. Select **Wi-Fi** and then click **Find wireless network**.
4. The list of available wireless networks will be loaded. Select the network to connect to.
5. If the network is password secured, you will be prompted to enter the password.
6. Restart the device. Go back to the **Advanced settings** main menu and select **Restart Device**.



#### CAUTION

A change of the network interface will not be applied until the device is restarted.



#### NOTE

You can also make network settings in the web configuration interface in **System > Network Connection**.

## Access to web device configuration

Configure **2N Indoor View Wi-Fi** via a web configuration interface, which is accessible from a web browser.

You need to know the IP address or domain name of the device for access to the interface. Make sure that the device is connected to the local IP network and powered.



The web configuration interface can also be accessed from the connected My2N portal or the 2N Access Commander configuration tool.

### Web Configuration Interface Login

1. Start your Internet browser.
2. Enter the device IP address or domain name (refer to Subs.[Finding devices in the network \(p. 27\)](#)).
3. If no certificate has been generated for the IP address, a security certificate invalidity notification may appear. In that case, confirm that you want to go to the web configuration interface.
4. The login screen is now displayed.
5. Enter the login data.  
The default login data are:
  - Username: **Admin**
  - Password: **2n**

6. After the first login, change the password.

## Access from 2N Access Commander

1. Log in to the Access Commander interface.
2. Go to the  Devices page.
3. For the selected device, press .

## Password Change

You must change the default password to get full access to the web configuration interface features. You cannot configure the device without changing the default password.



### TIP

It is recommended that a password is used that is difficult to break. It is not recommended that names, places or things, especially those closely related to the user, are used in the password.

For increased password security, it is recommended that:

- the random password generator is used,
- the password length is 12 characters at least,
- various characters from different character sets are combined (small/capital letters, digits, special characters, etc.).

## Recommended browsers

The web configuration interface is optimized for the Chromium-based web browsers (Google Chrome, Microsoft Edge or Opera, e.g.). With other browsers, there may be slight differences in the interface function and appearance.

## Firmware Update

New firmware versions are available on the update server. If the web configuration interface does not provide access to the public Internet, it is possible to upload the firmware file manually to the device.



### NOTE

Firmware updates are not automatic. To ensure system integrity and eliminate unintentional failures, all updates must be manually confirmed or initiated by the user. Please check the release notes of the new version and verify compatibility with your existing infrastructure before performing any updates.

## Getting Firmware from Update Server

1. Go to **System > Maintenance > Firmware**.
2. Click **Check for Updates**.
3. If an update is available, its release notes are loaded. To start the upgrade, click **Upgrade** in the window header.

4. Once the firmware is uploaded successfully, the device is restarted automatically. After the restart, the device becomes fully operational with a new firmware version. The FW upgrade does not affect configuration.

## Uploading New Firmware from Storage

1. Go to **System > Maintenance > Firmware**.
2. Click **Upload Firmware**.
3. In the open dialog box, select a file from your own storage.
4. Click **Upload** to confirm the file upload.  
The device checks the firmware file and prevents you from uploading an incorrect or corrupt file.
5. Once the firmware is uploaded successfully, the device is restarted automatically. After the restart, the device becomes fully operational with a new firmware version. The FW upgrade does not affect configuration.



### NOTE

The functions, reliability and security of the device depend on the firmware installed. Regular firmware upgrades to the latest version are included in the product terms of use. Errors that may be caused by the use of an outdated firmware version cannot be the subject of a claim. The current firmware implements customer experience and requirements in the field of personal data security.

## Device Restart

To restart the device choose one of the following options:

- using power disconnection and reconnection
- via the web configuration interface.
- using the device buttons
- using the RESET button,

The device restart does not result in any change in the configuration settings.



### CAUTION

Do not touch the display during reboot, it is being calibrated.

## Restart Using Web Configuration Interface

1. Open the web configuration interface.
2. Go to **System > Maintenance**.
3. Press **Restart Device** in the page header.

## Restart Using Device Buttons

Restart the device in Settings > Advanced settings.

Enter a code to access the Advanced settings. Set the Advanced settings access code in the web configuration interface (Hardware > Display > Advanced settings code > Advanced settings code).

## Restart Using RESET Button

Press the button shortly (< 1 s) to restart the system without changing configuration.

Find the RESET button on the [device backside](#) (p. 8).

## Factory Default Reset

The factory settings can be restored

- via the web configuration interface.
- Use hardware (RESET button).

### Factory Default Reset via Web Configuration Interface

Soft reset the device factory default values in **System > Maintenance** using Default Reset.

### Factory Default Reset with RESET Button

1. Press the button RESET and keep it pressed.
  - a. Wait until the red and green LEDs go on simultaneously on the device and the acoustic signal can be heard 🎵 (approx. 15–35 s).
  - b. Wait until the red LED goes off and an acoustic signal can be heard 🎵 (approx. for another 3 s).
  - c. Wait until the green LED goes off and the red LED goes on again and an acoustic signal can be heard 🎵🎵🎵 (approx. for another 3 s).
  - d. Wait until the red LED goes off and the acoustic signal can be heard 🎵🎵🎵🎵 (approx. for another 3 s).
2. Release the RESET button.

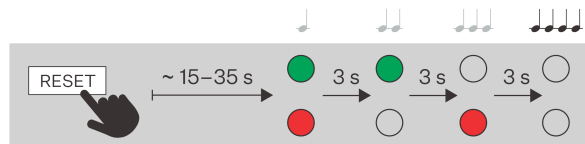

## Configuration via Hardware

Where software configuration is unavailable, make basic settings using the RESET button (refer to 1.).

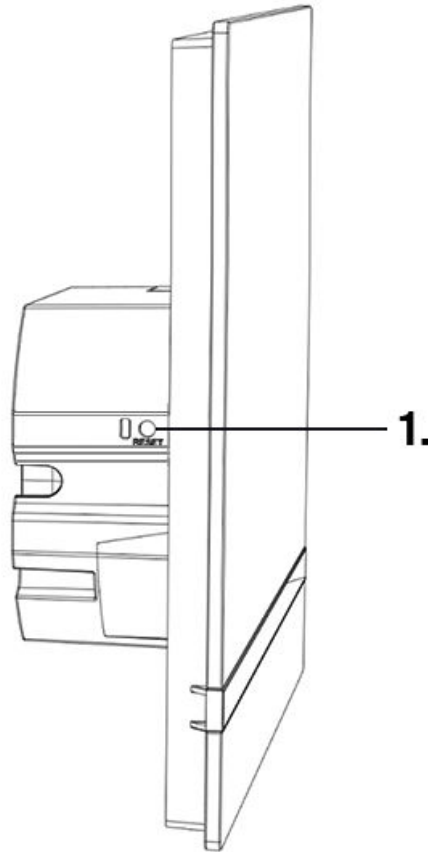

The RESET button helps you retrieve the device IP address, switch the dynamic/static IP address mode or reset the factory values.

### Device Restart

Press the button shortly (< 1 s) to restart the system without changing configuration.



#### CAUTION

Do not touch the display during reboot, it is being calibrated.

### IP Address Retrieval Using the RESET button

Follow the instructions below to retrieve the current IP address:

1. Press the button RESET and keep it pressed.
  - a. Wait until the red and green LEDs go on simultaneously on the device and the acoustic signal can be heard (approx. 15–35 s).
2. Release the RESET button.

- The device announces the current IP address via the speaker automatically.

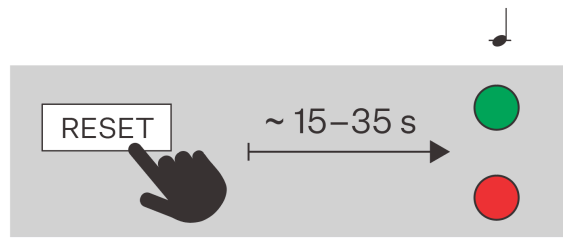



**NOTE**

The delay after pressing RESET till the first light and sound signaling is set to 15–35 s depending on the device model used.

### Static IP Address Setting with RESET Button

Follow the instructions below to switch on the Static IP address mode (DHCP OFF):

- Press the button RESET and keep it pressed.
  - Wait until the red and green LEDs go on simultaneously on the device and the acoustic signal can be heard  (approx. 15–35 s).
  - Wait until the red LED goes off and an acoustic signal can be heard  (approx. for another 3 s).
- Release the RESET button.

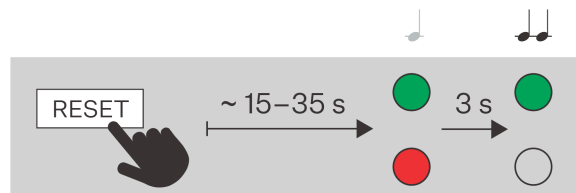

**NOTE**

The following network parameters will be set after restart:

- IP address: 192.168.1.100
- Network mask: 255.255.255.0
- Default gateway: 192.168.1.1

### Dynamic IP Address Setting via RESET

Follow the instructions below to switch on the Static IP address mode (DCHP ON):

1. Press the button RESET and keep it pressed.
  - a. Wait until the red and green LEDs go on simultaneously on the device and the acoustic signal can be heard 🎵 (approx. 15–35 s).
  - b. Wait until the red LED goes off and an acoustic signal can be heard 🎵 (approx. for another 3 s).
  - c. Wait until the green LED goes off and the red LED goes on again and an acoustic signal can be heard 🎵🎵🎵 (approx. for another 3 s).
2. Release the RESET button.

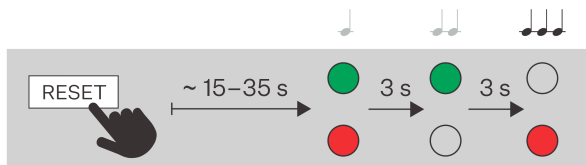

### Factory Default Reset with RESET Button

1. Press the button RESET and keep it pressed.
  - a. Wait until the red and green LEDs go on simultaneously on the device and the acoustic signal can be heard 🎵 (approx. 15–35 s).
  - b. Wait until the red LED goes off and an acoustic signal can be heard 🎵 (approx. for another 3 s).
  - c. Wait until the green LED goes off and the red LED goes on again and an acoustic signal can be heard 🎵🎵🎵 (approx. for another 3 s).
  - d. Wait until the red LED goes off and the acoustic signal can be heard 🎵🎵🎵 (approx. for another 3 s).
2. Release the RESET button.

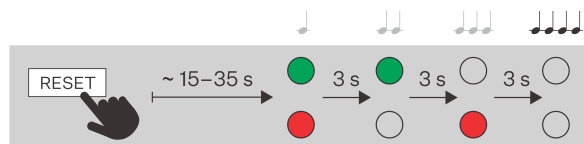

# Web configuration interface

Indoor Stations

## First Login

### Finding devices in the network

You need to know the IP address or domain name of the device for access to the interface. Make sure that the device is connected to the local IP network and powered.

### Domain Name

To access the web configuration interface, you can enter the domain name into the browser in the format “hostname.local” instead of the IP address. The hostname of a new device consists of the product name and serial number of the device. While entering a hostname, use only letters and digits; do not use spaces, periods, dashes, or other special characters.

**Default domain name 2N Indoor View Wi-Fi:** 2NIndoorViewWiFi-{serial number without dashes}.local (e.g.: “2NIndoorViewWiFi-0000000001.local”)

The format of the device name is specified in the Installation Manual for the specific product in the Domain Name subsection.



#### TIP

You can change the hostname later in the web configuration interface at **System > Network Connection > Advanced Configuration > Hostname**.

Login based on a domain name is advantageous if the dynamic IP address is used. While the dynamic IP address changes, the domain name remains the same. It is possible to generate certificates signed by a trusted certification authority for the domain name.

### Device IP Address

By factory default, **2N Indoor View Wi-Fi** uses a dynamic IP address assigned by the DHCP server.

The 2N IP Utility application helps find the 2N device IP address in the LAN. Download 2N IP Utility from the [2N.com](https://www.2n.com) website. Make sure that Microsoft .NET Framework 4.7.2 is installed for successful app installation.

Depending on the capabilities of the device, you can also retrieve the IP address in one of the following ways:

- with the RESET button
- on the device display (see the product Installation Manual for the procedure)

### IP Address Retrieval Using 2N IP Utility

The 2N IP Utility application helps find the 2N device IP address in the LAN. Download 2N IP Utility from the [2N.com](https://www.2n.com) website. Make sure that Microsoft .NET Framework 4.7.2 is installed for successful app installation.

1. Run the 2N IP Utility installer.
2. The Installation Wizard will help you with the installation.

## Web configuration interface

- Having installed 2N IP Utility, start the application using the Microsoft Windows Start menu. Once started, the application begins to automatically search the LAN for all the 2N and AXIS devices which have been DHCP/statically assigned IP addresses. These devices are then shown in a table.

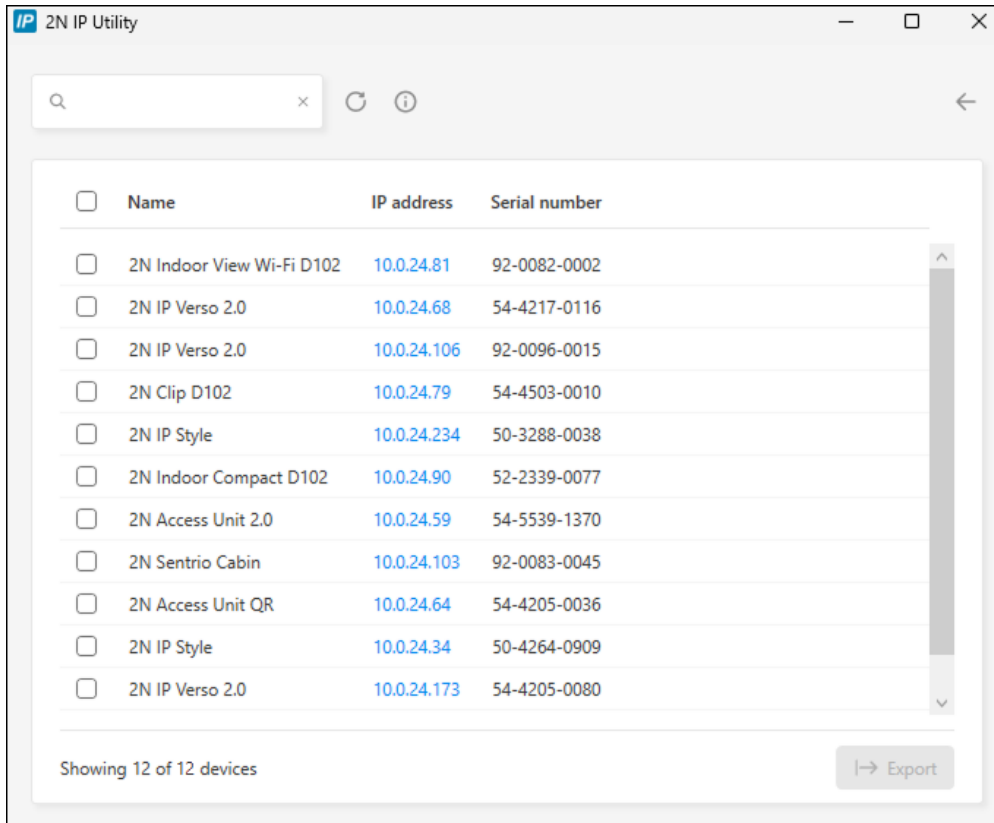

- Select the device to be configured and left-click it. This opens the right-hand part of the web configuration interface window.



### TIP

- Access to the web configuration interface is also possible via the **Open in external browser** button, which opens the interface in a separate browser window.
- Click a device in the list to display detailed information. Click the **IP settings** button to change the IP address by entering the required static IP address or activating DHCP.
- The application also allows you to export selected devices into a CSV file. First select a device by ticking the boxes in the list, then use the **Export** button that appears at the bottom of the window. The exported file shall include the names, IP addresses and serial numbers of the selected devices.

The default login data are:

Username: **Admin**

Password: **2n**

It is necessary to change the password immediately upon the first login.



**TIP**

It is recommended that a password is used that is difficult to break. It is not recommended that names, places or things, especially those closely related to the user, are used in the password.

For increased password security, it is recommended that:

- the random password generator is used,
- the password length is 12 characters at least,
- various characters from different character sets are combined (small/capital letters, digits, special characters, etc.).

### IP Address Retrieval Using the RESET button

Follow the instructions below to retrieve the current IP address:

1. Press the button RESET and keep it pressed.
  - a. Wait until the red and green LEDs go on simultaneously on the device and the acoustic signal can be heard (approx. 15–35 s).
2. Release the RESET button.
3. The device announces the current IP address via the speaker automatically.



**NOTE**

The delay after pressing RESET till the first light and sound signaling is set to 15–35 s depending on the device model used.

### DHCP Switching

By factory default, **2N Indoor View Wi-Fi** uses a dynamic IP address assigned by the DHCP server.

#### Dynamic IP Address

DHCP (Dynamic Host Configuration Protocol) is a network protocol that maintains a list of available IP addresses and automatically assigns them to devices in the LAN. The assigned IP address is dynamic, so the device can be assigned a new IP address after a period of time (lease time).

#### Static IP Address

If the IP address of the device is to remain unchanged, you must disable IP address allocation by the DHCP server on the device. You can disable the DHCP server in the web configuration interface or using the device hardware.



**NOTE**

The specific values for the static IP address can only be set in the web configuration interface of the device.

**Setting Network Parameters in Web Configuration Interface**

1. Go to the web configuration interface.
2. Go to **System > Network Connection > Basic Settings > IP Address Settings**.
3. Set the desired network parameters.
4. Save your changes.

**Switching DHCP on Device Hardware**

Depending on the capabilities of the device, the IP address can be switched as follows:

- with the RESET button
- on the device display (see the product Installation Manual for the procedure)





**TIP**

Please refer to the product Installation Manual for the location of the RESET button.

**Dynamic IP Address Setting via RESET**

Follow the instructions below to switch on the Static IP address mode (DCHP ON):

1. Press the button RESET and keep it pressed.
  - a. Wait until the red and green LEDs go on simultaneously on the device and the acoustic signal can be heard  (approx. 15–35 s).
  - b. Wait until the red LED goes off and an acoustic signal can be heard  (approx. for another 3 s).
  - c. Wait until the green LED goes off and the red LED goes on again and an acoustic signal can be heard  (approx. for another 3 s).
2. Release the RESET button.

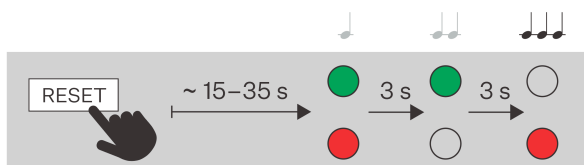

**Static IP Address Setting with RESET Button**

Follow the instructions below to switch on the Static IP address mode (DHCP OFF):

## Web configuration interface

1. Press the button RESET and keep it pressed.
  - a. Wait until the red and green LEDs go on simultaneously on the device and the acoustic signal can be heard 🗣️ (approx. 15–35 s).
  - b. Wait until the red LED goes off and an acoustic signal can be heard 🗣️ (approx. for another 3 s).
2. Release the RESET button.

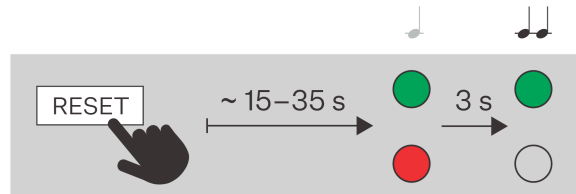

### NOTE

The following network parameters will be set after restart:

- IP address: 192.168.1.100
- Network mask: 255.255.255.0
- Default gateway: 192.168.1.1

## Access to web device configuration

Configure **2N Indoor View Wi-Fi** via a web configuration interface, which is accessible from a web browser.

You need to know the IP address or domain name of the device for access to the interface. Make sure that the device is connected to the local IP network and powered.

The web configuration interface can also be accessed from the connected My2N portal or the 2N Access Commander configuration tool.

## Web Configuration Interface Login

1. Start your Internet browser.
2. Enter the device IP address or domain name (refer to Subs.[Finding devices in the network \(p. 27\)](#)).
3. If no certificate has been generated for the IP address, a security certificate invalidity notification may appear. In that case, confirm that you want to go to the web configuration interface.
4. The login screen is now displayed.
5. Enter the login data.

The default login data are:

  - Username: **Admin**
  - Password: **2n**
6. After the first login, change the password.

## Access from 2N Access Commander

1. Log in to the Access Commander interface.
2. Go to the  Devices page.

3. For the selected device, press .

## Password Change

You must change the default password to get full access to the web configuration interface features. You cannot configure the device without changing the default password.



### TIP

It is recommended that a password is used that is difficult to break. It is not recommended that names, places or things, especially those closely related to the user, are used in the password.

For increased password security, it is recommended that:

- the random password generator is used,
- the password length is 12 characters at least,
- various characters from different character sets are combined (small/capital letters, digits, special characters, etc.).

## Recommended browsers

The web configuration interface is optimized for the Chromium-based web browsers (Google Chrome, Microsoft Edge or Opera, e.g.). With other browsers, there may be slight differences in the interface function and appearance.

## Basic Device Settings

### Firmware Update

New firmware versions are available on the update server. If the web configuration interface does not provide access to the public Internet, it is possible to upload the firmware file manually to the device.



### NOTE

Firmware updates are not automatic. To ensure system integrity and eliminate unintentional failures, all updates must be manually confirmed or initiated by the user. Please check the release notes of the new version and verify compatibility with your existing infrastructure before performing any updates.

## Getting Firmware from Update Server

1. Go to **System > Maintenance > Firmware**.
2. Click **Check for Updates**.
3. If an update is available, its release notes are loaded. To start the upgrade, click **Upgrade** in the window header.
4. Once the firmware is uploaded successfully, the device is restarted automatically. After the restart, the device becomes fully operational with a new firmware version. The FW upgrade does not affect configuration.

## Uploading New Firmware from Storage

1. Go to **System > Maintenance > Firmware**.
2. Click **Upload Firmware**.
3. In the open dialog box, select a file from your own storage.
4. Click **Upload** to confirm the file upload.  
The device checks the firmware file and prevents you from uploading an incorrect or corrupt file.
5. Once the firmware is uploaded successfully, the device is restarted automatically. After the restart, the device becomes fully operational with a new firmware version. The FW upgrade does not affect configuration.



### NOTE

The functions, reliability and security of the device depend on the firmware installed. Regular firmware upgrades to the latest version are included in the product terms of use. Errors that may be caused by the use of an outdated firmware version cannot be the subject of a claim. The current firmware implements customer experience and requirements in the field of personal data security.

## Directory

The Directory section is a key part of the device configuration. In the directory, you can create users and their phone connection parameters.

### Adding User Manually to Directory

1. Click **Add User** on the Directory page.
2. The user detail will open. Name the user on the Personal Information tab.
3. Set the device phone number of the contact according to [Creating Calling Contacts \(p. 33\)](#).

### Bulk User Management in Access Commander or My2N

If the device is managed through the Access Commander or My2N bulk configuration tools, any changes made in the web configuration interface are overwritten by the settings in the bulk configuration tool. A user created directly in the web interface will be deleted.

The **Holder** column in the Directory table specifies the bulk configuration tool that created the user. The **Holder** column is hidden by default.

## Calling

The 2N device provides several ways of connecting calls. Before creating contacts and setting the dialing method, you must first activate and set the call mediating services:

- [Calling via SIP \(p. 34\)](#)
- [Local Calls between 2N Devices \(p. 36\)](#)
- other special integrations

### Creating Calling Contacts

Creating a calling contact consists of adding a phone number to the corresponding user in the device directory.



**TIP**

You can use the Local calls function to connect to another 2N device in your LAN, refer to [Adding 2N Local Device \(p. 34\)](#).

1. Go to **Directory**.
2. Open the user detail by clicking on the row or select **Add User** to create a new user.
3. On the **Phone Numbers** tab, click  to open the phone number editing.
4. Select **Call Type** for the contact (SIP, local network, MS Teams, VMS, ...).
  - [Calling via SIP \(p. 34\)](#) – for VoIP services and accounts
  - [Local Calls between 2N Devices \(p. 36\)](#) – for calls to 2N devices
  - MS Teams, VMS,... – for special integrations
5. Enter the destination number or address for the device to call.  
Enter the extension number, SIP URI (e.g. "sip:101@192.168.1.50"), domain name (e.g. "2NIPVer-so20-22222222" or another number as set in the Call Type) as necessary.
6. Set additional call features that affect the call behavior in **Options**.  
These options allow the administrator to configure the security, functionality and dialing logic to suit the exact needs of the facility, for example, to use encrypted transmission, speed up the connection or enable door reverse opening.
7. Specify the time limit when the number can be called in the **Availability** section. For example, you can set availability only for the user's working hours.
8. Click **Confirm** to save the change.

## Adding 2N Local Device



**CAUTION**

Local Calls must be enabled on both this and the device to be searched with the identical **Access Key**, refer to [Local Calls between 2N Devices \(p. 36\)](#).

1. Click **Add Local Device** on the **Directory** page.
2. In the open dialog box, check the device to get connected to.
3. Select **Add to Directory**.
4. A new user appears in the directory with one phone number set.
5. Click the user row to edit it further.

## Dialing Calls on Device

The dialing method for specific contacts is set directly in the contact detail in the directory.

## Calling via SIP

### Device Registration to SIP Server

Registration to the SIP server is crucial for full functionality of the device in a SIP environment.

1. Go to **Calling > SIP** of the account to be set up.
2. Enable the SIP account at the top.

3. On the **Device Identity** tab, fill in:
  - **Display Name** – this text will be displayed to the other party as caller ID.
  - **Phone Number (ID)** – together with the domain, this number uniquely identifies the device in calls and registration.
  - **Domain** – set the domain name of the service with which the device is registered. Typically, it is equivalent to the SIP Proxy or SIP Registrar address.

These three values combined identify the device in the SIP environment.
4. In **Authentication**, fill in the login credentials assigned by the SIP server administrator to authenticate the device to the SIP Proxy server. This authentication prevents unauthorized access, fraudulent calls or identity fraud.
 

If **Authentication ID** is not filled in, the device will authenticate with **Phone Number**.
5. Under **Transport Protocol Options**, select the protocol to be used by the SIP server.
6. Enable the **SIP Registrar** feature.
7. Fill in the details of the SIP registrar with which you want to register the 2N device.
 

If you leave the **Port** parameter empty or the parameter value is 0, the default port is applied according to the selected transport protocol.

### Default Port Values according to Transport Protocol

Account	UDP / TCP	TLS
SIP 1	5060	5061
SIP 2	5062	5063
SIP 3	5064	5065
SIP 4	5066	5067

8. The tab header shows the registration status and the registration error messages.



**NOTE**

Further SIP account settings are described in Subs. [Advanced SIP Account Settings \(p. 38\)](#).

### Setting Public Device IP Address

This setting is used when the device is located behind a router (NAT) and communicates with the PBX outside the LAN (in the cloud or over the Internet, e.g.). In SIP communication, the device must specify the public IP address under which it is accessible from the Internet. If it sent its internal IP address, the PBX would not be able to route the call or RTP data stream correctly.

If the device and the PBX are on one and the same LAN, it is unnecessary to set the public IP address.

1. Go to **Calling > SIP** of the account to be set up.

2. On the **Public IP Address** tab select one of the following options:
  - **STUN (Automatic)**  
Fill in the details of your STUN server.
  - **Enter Manually**  
Enter your own external IP address for the device.

## Local Calls between 2N Devices

It is possible to set up the so-called local calls between the 2N IP devices, which allow for direct communication between 2N devices within one LAN without the need to connect to a SIP server or external infrastructure.

### Activating Local Calls

1. Go to **Calls > Local Calls**.
2. Enable the feature in the page header.
3. Set the access keys to ensure secure communication with other devices on the network.  
The access keys ensure that only devices with identical keys can communicate with each other. This contributes to security and the ability to define independent groups of devices.

## Display Settings

### Custom Display Language Upload

The web configuration interface allows you to customize the language texts displayed on the device. Thus, you can adapt the device to a different language environment or display custom messages.

1. In the web configuration interface, go to **Customization > Display**.
2. Download the translation file template on the **Language** tab. The template contains default English texts.
3. Open the downloaded file in a text editor.
4. Replace the English expressions in the file with your own texts.



#### CAUTION

Do not change the structure and format of the key phrases. If the syntax is modified or some items are missing, the translation file may not load correctly.

5. Save the modified file in the format `.ini`.
6. Return to the **Language** tab in the web interface and select “Custom” from the language drop-down menu.
7. The file upload option will appear – select and upload your modified `.ini` file.
8. Save the changes after successful upload.

## Advanced Settings

### Sound Settings

#### Device Volume Setting

To adjust the volume of your device, go to **Customization > Audio**.

#### Audio Transmission in Calls

The call audio parameters are set directly on the tab of the service that provides the call ([Calling via SIP \(p. 34\)](#) or [Local Calls between 2N Devices \(p. 36\)](#)), in the **Video** folder.

1. Open the **Calling** section.
2. Go to the page of the service providing the call (specific SIP account, Local calls).

3. Open the **Audio** tab.
4. Here set the necessary sound parameters.

### DTMF Signal Transmission Enable

It is possible to switch on the door lock and thus open the door using the DTMF commands sent to this device.

1. Open the **Calling** section.
2. Go to the page of the service providing the call (specific SIP account, Local calls).
3. Open the **Audio** tab.
4. On the **Sending DTMF** tab, select **Sending Mode** to determine during which calls the DTMF signals can be sent.
5. Select the required DTMF sending methods.



#### TIP

Check that you have enabled the methods that are accepted by the device to be called.

6. Then set the DTMF methods that the device will receive on the **Receive DTMF** tab.
7. Save the changes.

### User Sounds

The device performs several actions that are accompanied by sound (ringing, switching, etc.). You can change the sounds to be played in **Customization > User Sounds**.

Up to 10 custom user sounds can also be uploaded to the device.

### Time Profiles

Some of the functions performed by the device are time dependent. The **Time Profiles** section allows you to preset time intervals and select them for these functions. This means you do not have to manually enter time whenever you set a time profile. You can name the time profile for better clarity.

#### Time Profile Creation:

1. Go to **Customization > Time Profiles**.
2. Click on empty to create a new profile.
3. Enter a profile name.
4. Click **Save**. The profile detail will open.
5. Set the intervals at which the time profile should be active.
  1. Click on the required interval.
  2. You can specify the profile start and end in an open menu.



#### NOTE

The **Holidays** line helps you set different time intervals during selected days, see [Holidays \(p. 37\)](#).

6. Save the changes.

### Holidays

In the device configuration, you can define several days that will be marked as holidays. Special intervals are then set in the time profiles for these days. Typically, these are such days as public holidays, company holidays and other special days.

For each holiday, you specify whether it applies only to a particular year or whether it repeats on the same day each year. Holidays can be planned several years in advance.

## Holiday Settings:

1. Go to **Customization > Time Profiles > Holidays**.
2. Select the year for which you want to set the holiday.
3. Click a day in the calendar:
  - The first click marks the holiday that will be repeated on the given day and month every year.
  - The second click changes the holiday to a one-time holiday for the selected year.
4. Save the changes.

## Advanced SIP Account Settings

This section describes the optional features and SIP account parameters that are set in the **Calling > SIP** section.

The advanced SIP account settings allow you to increase security, optimize call quality and ensure compatibility with different PBXs. We recommend that only experienced administrators change the settings.

1. Go to **Calling > SIP** of the account to be set up.

## SIP Functions

The REFER method allows for dynamic forwarding of active calls between various SIP identities, which provides a more flexible control of communication flows.

The PRACK method provides reliable acknowledgement of continuous call states between devices, which improves the communication quality and stability in SIP systems.

## Media

**Receive Only Encrypted Calls (SRTP)** – allows you to receive SRTP-encrypted calls only. Unencrypted calls will be automatically rejected. At the same time, TLS is recommended as the SIP transport protocol for higher security.

**Encrypted Outgoing Calls (SRTP)** – set that outgoing calls shall be SRTP encrypted on this account. At the same time, TLS is recommended as the SIP transport protocol for higher security.

**Adaptive Control of Video Quality** – enable the use of extended RTP profile for feedback via the RTCP (RTP/AVPF). Enable the use of interactive video quality control according to RFC-4585 allowing for adaption of the video data flow to the currently available network connection quality.

**Broadsoft Compatibility Mode** – set the Broadsoft PBX compatibility mode. Having received re-invite from a PBX in this mode, the intercom replies by repeating the last sent SDP with currently used codecs instead of sending a complete offer.

**Use MKI in SRTP Packets** – enable the use of MKI (Master Key Identifier) if required by the counterparty for master key identification when multiple keys rotate in the SRTP packets.

**Do Not Play Incoming Early Media** – disable playing of the incoming audio stream before call pick-up, which is sent by some PBXs or other devices. A standard ringtone will be played instead.

## Advanced Configuration

**Sending KeepAlive Packets** – set that the device shall send STUN/CRLF packets to the registrar on a regular basis and also SIP OPTIONS during calls to keep the setup connection active.

**SRV Record Rotation** – allow SRV record rotation for SIP Proxy and Registrar. It is an alternative method of transition to backup servers in the event of main server failure or unavailability.

**IP Address Filter** – enable the blocking of SIP packet receiving from addresses other than SIP Proxy and SIP Registrar. The primary purpose of the function is to enhance communication security and eliminate unauthorized phone calls.

## Evaluating Older Backup Status -

**QoS DSCP Value** – set the SIP packet priority in the network. The set value is sent in the TOS (Type of Service) field in the IP packet header. Enter the value as a decimal number.

## System

### Date and Time Settings



#### CAUTION

If the device is managed by a bulk management tool (2N Access Commander / 2N My2N), the device time can be managed by this tool. Manual changes in the device web interface do not affect the time setting.

### NTP Synchronization

If the device is connected to the Internet, the time and date values can be synchronized using NTP.

1. Go to **System > Date and Time**.
2. Activate the **Automatic Time from NTP or Internet** option on the **Time Synchronization Settings** tab.
3. Enter the address of the NTP server of your choice.

### Time Update at Outage

1. Go to **System > Date and Time**.
2. Click **Sync with Browser** on the **Time Sync Settings** tab.  
This synchronizes the device time with your PC time.



#### NOTE

The 2N devices are equipped with a real-time clock to back up the device for even a few days in case of power outage.

## Network Configuration

By factory default, **2N Indoor View Wi-Fi** uses a dynamic IP address assigned by the DHCP server.

A proper IP address configuration is crucial for a stable and reliable connection of the device to your network.

1. Go to **System > Network Connection** to set the device network parameters.
2. You can enable/disable the DHCP server in Basic Settings > IP Address Settings.

#### Static IP Address Setting:

- a. Disable the **DHCP Server** option.
- b. Enter the desired IP address, subnet mask, default gateway and DNS servers.
- c. Save your changes. The device will be restarted.

#### DHCP Settings

- a. Enable the **DHCP Server** option.
- b. Enter the desired IP address, netmask, default gateway and DNS servers.
- c. Save your changes. The device will be restarted.

**NOTE**

If you use the RADIUS server and 802.1x-based verification of connected equipment, you can make the devices use the EAP-MD5 or EAP-TLS authentication. Set this function on the 802.1x tab.

**Used Ports**

Service	Port	Protocol	Direction	On by default	Configurable	Settings
802.1x	–	–	In/Out	×	×	–
DHCP	68	UDP	In/Out	✓	×	–
DNS	53	TCP/UDP	In/Out	✓	×	–
Echo (device discovery)*	8002	UDP	In/Out	✓	×	–
2N IP Eye	8003	UDP	Out	×	×	–
HTTP	80	TCP	In/Out	✓	✓	<b>System &gt; Network connection &gt; WEB SERVER tab</b>
HTTPS	443	TCP	In/Out	✓	✓	<b>System &gt; Network connection &gt; WEB SERVER tab</b>
Multicast audio for ICU protocol	8006	UDP	Out	×	×	–
Multicast video for ICU protocol	8008	UDP	Out	×	×	–

Web configuration interface

Service	Port	Protocol	Direction	On by default	Configurable	Settings
Multicast video (wide) for ICU protocol	8016	UDP	In/Out	×	×	–
NTP client	123	UDP	In/Out	✓	×	–
RTP+RTCP ports (SIP)	4900+ (range of 64 ports)	UDP	In/Out	×	✓	<b>Calling &gt; General Settings</b>
RTP+RTCP ports (external camera)	4800+ (range of 64 ports)	UDP	In/Out	×	✓	<b>Integration &gt; ONVIF / RTSP</b>
RTSP client	554	UDP	In/Out	×	✓	
SLP	427	UDP	In/Out	✓	×	–
SIP	5060, 5062	TCP/UDP	In/Out	×	✓	<b>Calling &gt; SIP</b>
SIPS	5061	TCP	In/Out	×	✓	<b>Calling &gt; SIP</b>
Syslog	514	UDP	Out	×	×	–
My2N Knocker	443	TCP	Out	✓	×	–
My2N Tribble Tunnel	443	TCP	Out	✓	×	–
Sitechannel (ICU protocol)	8004	UDP	In/Out	×	×	–
Multicast DNS	5353	UDP	In/Out	✓	×	–

## Device Control

2N Indoor View Wi-Fi is equipped with a touch display for intuitive control.

### Idle Mode



The device will automatically go into the Idle mode if there is no activity (after selection of the 15s –10min timeout). The device configuration allows date and time, the current weather information and door contact state to be displayed in the Idle mode if configured so.

## Home Screen

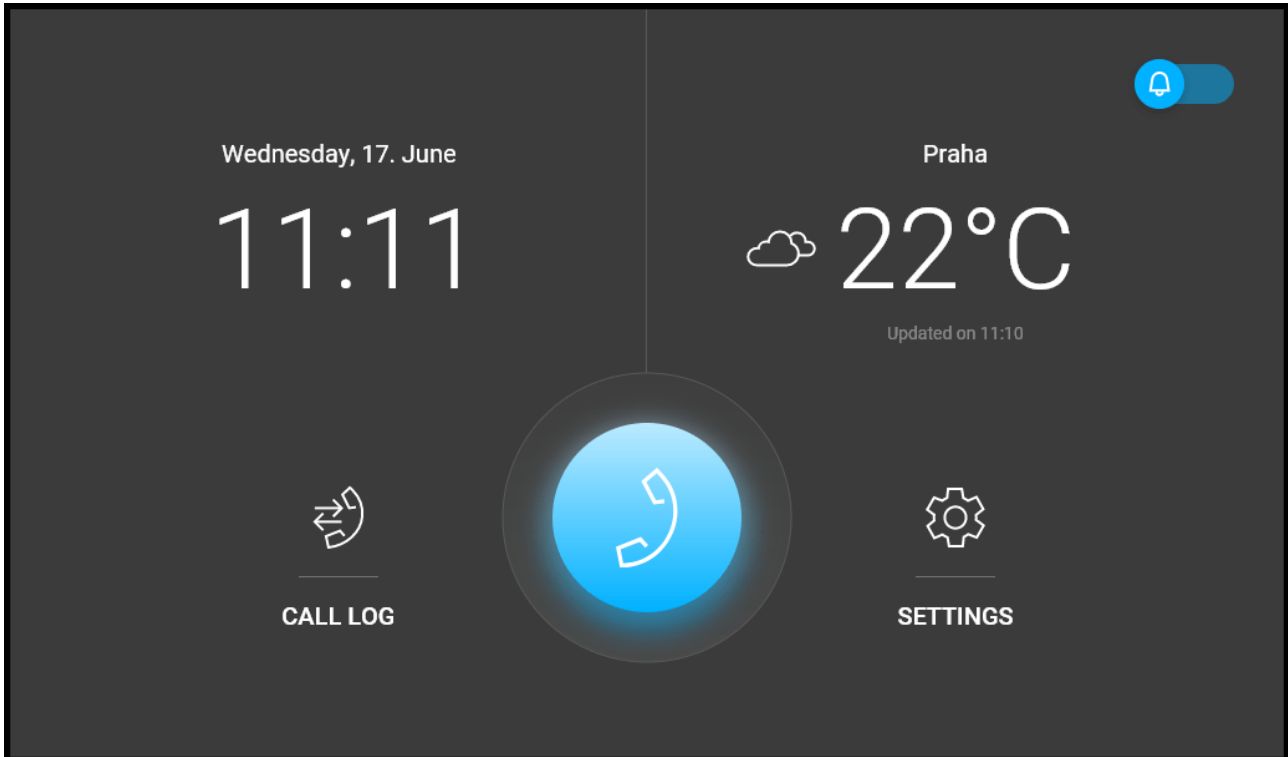

The Home screen is set as the start screen, which is displayed when the device is switched from the Idle mode by a finger touch. It shows the current date, time, temperature and location and provides access to the Logs, Directory and Settings as well as direct activation of the Do Not Disturb mode. The device configuration allows you to display the door contact state notifications and buttons with the selected icons of the configured HTTP commands on the Home screen.



### TIP

A long press on the Home page location / current weather area automatically displays the Settings > Weather section.

## Configuration via Hardware

Where software configuration is unavailable, make basic settings using the RESET button (refer to 1.).

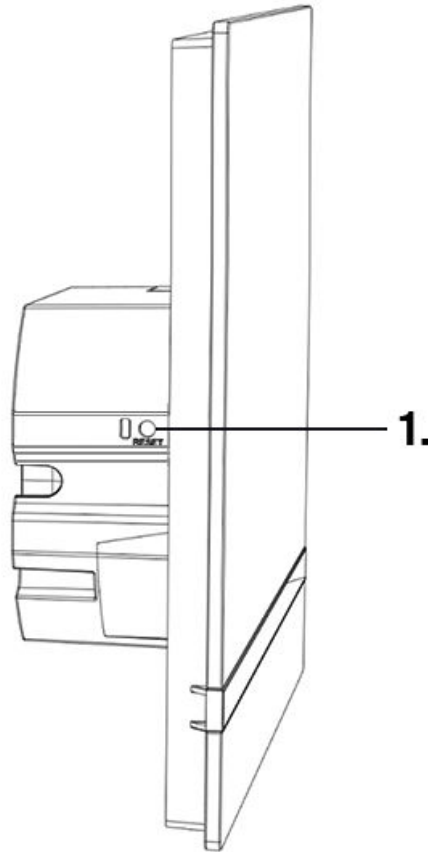

The RESET button helps you retrieve the device IP address, switch the dynamic/static IP address mode or reset the factory values.

### Device Restart

Press the button shortly (< 1 s) to restart the system without changing configuration.



#### CAUTION

Do not touch the display during reboot, it is being calibrated.

### IP Address Retrieval Using the RESET button

Follow the instructions below to retrieve the current IP address:

1. Press the button RESET and keep it pressed.
  - a. Wait until the red and green LEDs go on simultaneously on the device and the acoustic signal can be heard (approx. 15–35 s).
2. Release the RESET button.

3. The device announces the current IP address via the speaker automatically.

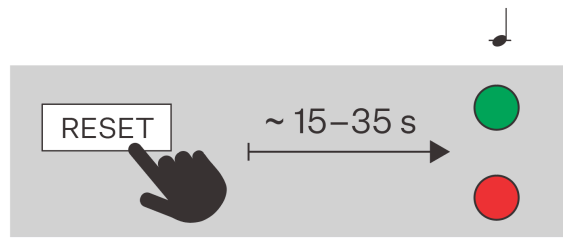



**NOTE**

The delay after pressing RESET till the first light and sound signaling is set to 15–35 s depending on the device model used.

**Static IP Address Setting with RESET Button**

Follow the instructions below to switch on the Static IP address mode (DHCP OFF):

1. Press the button RESET and keep it pressed.
  - a. Wait until the red and green LEDs go on simultaneously on the device and the acoustic signal can be heard  (approx. 15–35 s).
  - b. Wait until the red LED goes off and an acoustic signal can be heard  (approx. for another 3 s).
2. Release the RESET button.

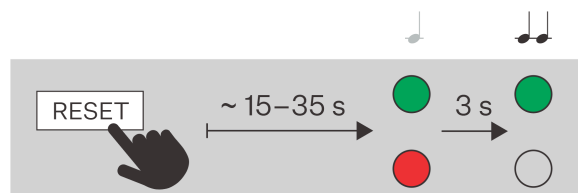

**NOTE**

The following network parameters will be set after restart:

- IP address: 192.168.1.100
- Network mask: 255.255.255.0
- Default gateway: 192.168.1.1

**Dynamic IP Address Setting via RESET**

Follow the instructions below to switch on the Static IP address mode (DCHP ON):

1. Press the button RESET and keep it pressed.
  - a. Wait until the red and green LEDs go on simultaneously on the device and the acoustic signal can be heard 🎵 (approx. 15–35 s).
  - b. Wait until the red LED goes off and an acoustic signal can be heard 🎵 (approx. for another 3 s).
  - c. Wait until the green LED goes off and the red LED goes on again and an acoustic signal can be heard 🎵🎵 (approx. for another 3 s).
2. Release the RESET button.

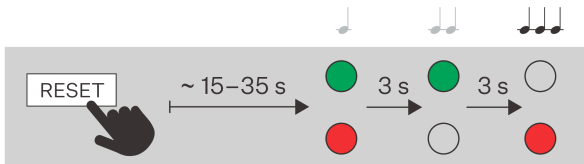

### Factory Default Reset with RESET Button



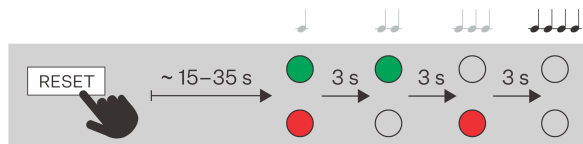











1. Press the button RESET and keep it pressed.
  - a. Wait until the red and green LEDs go on simultaneously on the device and the acoustic signal can be heard 🎵 (approx. 15–35 s).
  - b. Wait until the red LED goes off and an acoustic signal can be heard 🎵 (approx. for another 3 s).
  - c. Wait until the green LED goes off and the red LED goes on again and an acoustic signal can be heard 🎵🎵 (approx. for another 3 s).
  - d. Wait until the red LED goes off and the acoustic signal can be heard 🎵🎵🎵 (approx. for another 3 s).
2. Release the RESET button.



### Icons used on the display

Icon	Description
🎵	Receiving incoming call / Starting outgoing call
📞	Rejection of incoming call / Termination of outgoing/active call
🗑️	Remove

## Device Control

Icon	Description
	DND mode
	Device configuration
	Call Log
	Incoming call ringtone volume up
	Incoming call ringtone volume down
	Incoming call ringtone volume mute
	Value up
	Value down
	Microphone mute in call
	Unlocked, screen lock activated/deactivated
	Call info
	Camera Preview
	Camera 1
	Camera 2
N/A	Camera unavailable

Icon	Description
←	Back
📷	Camera Video Preview Zoom In
📶	Wi-Fi signal strength indicator
📶	Wi-Fi connection error
📶	Wi-Fi unavailable

## Home Screen

The Home screen is set as the start screen of the device, which is displayed whenever the device is activated by a display touch in the Idle mode.

The device displays:

- weather conditions in the given location
- missed call icon (if the call was from a device/number included in the Directory)
- Do Not Disturb icon
- HTTP command activation icon (as set in the device configuration)
- date
- Time

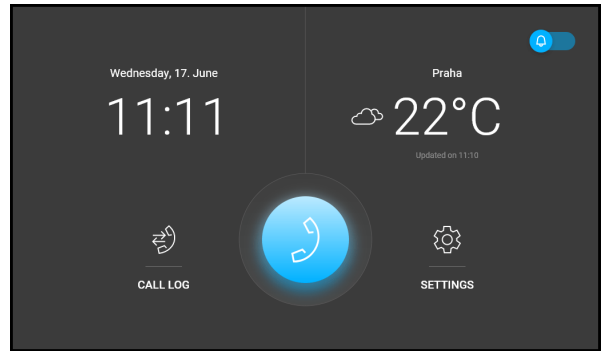

The home screen provides access to:

- Directory
- Call Log
- Settings



The dominant of the Home screen is a phone earpiece icon on a blue background, which allows you to make calls to the destinations listed in the Directory. If the earpiece icon is highlighted in red, **2N Indoor View Wi-Fi** cannot establish phone connections. This happens when the device has an unroutable address (0.0.0.0) or cannot log in to My2N or SIP Proxy.



### TIP

A long press on the Home page location / current weather area automatically displays the Settings > Weather section.

Possible actions	Performance	Action result
Display of Directory Menu		<a href="#">Directory Menu (p. 50)</a> is displayed.



Possible actions	Performance	Action result
Call Log Menu Display		<a href="#">Call Log (p. 52)</a> is displayed including a list of accomplished calls.
Do Not Disturb Activation		<a href="#">Do Not Disturb Mode (p. 66)</a> is activated and the activation message is displayed.
Settings Menu Display		<a href="#">Settings (p. 53)</a> is displayed on the device.
Send the set HTTP command	Press the set HTTP command icon	The HTTP command is sent to an external device.

## Directory Menu

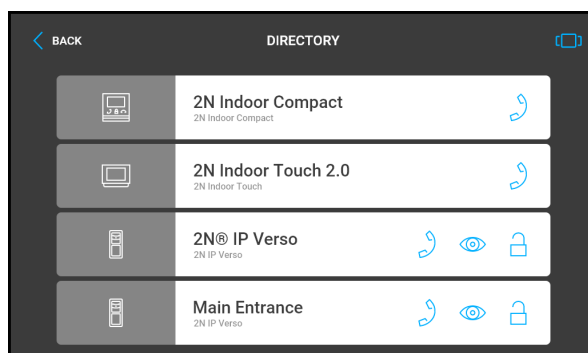
The Directory menu provides a list of contacts and connected external cameras.



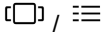

Possible actions	Performance	Action result
Outgoing call setup		An outgoing call is set up to the destination of the selected contact.

Possible actions	Performance	Action result
Target device lock opening		A specifically configured unlock code is sent to the target device and, if the code is compatible with the device, the target device lock opens. If no unlock code is set, the default unlock code is sent to the target device.
<div style="border: 1px solid #ccc; padding: 10px; background-color: #f9f9f9;">  <p><b>NOTE</b> If no unlocking code is set in the device and no default unlock code is set, the lock button is not displayed.</p> </div>		
Device detail display		The preview of the device camera is displayed if available.
HTTP command sending in call	Press the set HTTP command icon	The HTTP command is sent to an external device.
Directory display switch		<p>The Directory items can be displayed as:</p> <ul style="list-style-type: none"> <li>• a list in a column – scroll up/down to select an item,</li> <li>• tiles in a row – browse from right to left to select an item.</li> </ul>

## Call Log

Press  to display the call log.

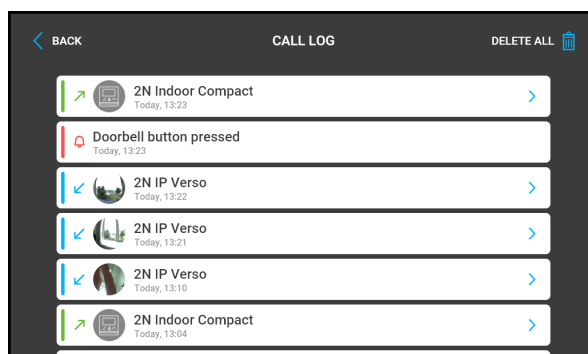

The device displays a list of all accomplished calls including date, time, status (outgoing , incoming  or missed ) and information on from/to which destination the call was made.

The maximum call log capacity is 20 calls. The log list and details provide door contact status information as configured (door open too long, door open by force).



### CAUTION

The device restart results in a deletion of the call list.

Possible actions	Performance	Action result
Show call detail	 or touch the selected call row	Call information and device camera preview if available are displayed.  If available, screenshots are displayed in the call detail and can be switched between. The screenshot time is shown in the right-hand upper corner.
Outgoing call setup	 in call detail	An outgoing call is set up to the selected record destination.
Selected Device Unlocking	 in call detail	A specifically configured unlock code is sent to the target device and, if the code is compatible with the device, the target device lock opens. If no unlock code is set, the default unlock code is sent to the target device.



### NOTE

If no unlocking code is set in the device and no default unlock code is set, the lock button is not displayed.

## Settings

Press the  button on the home screen to display the Device Settings section. The Settings menu helps you set the device locally.

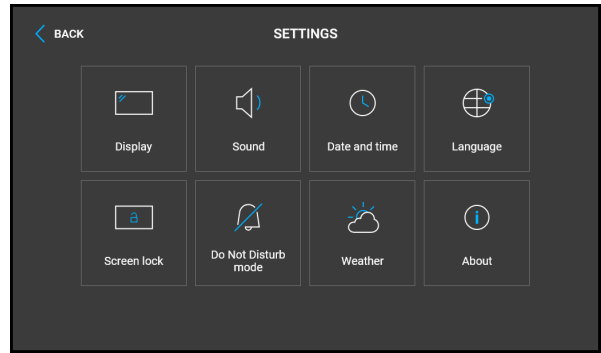

## Display

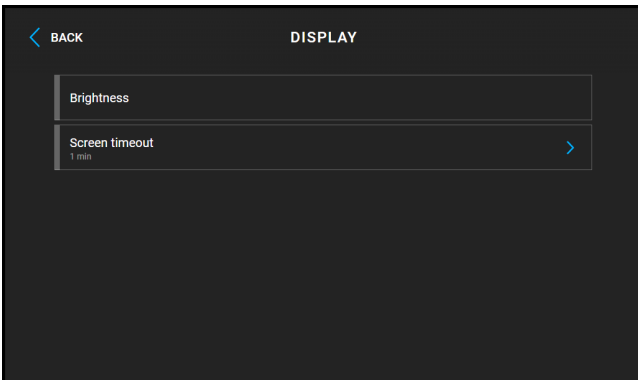

**Brightness** – sets the value of display backlighting.

**Screen timeout** – timeout after which the device automatically goes into Sleep Mode if there is no activity.

**Screen lock** – switches the screen lock or also the so-called parental lock on/off.

With the device lock on, enter the PIN code to enable the screen lock. Enter the same PIN code to disable the screen lock.

## Sound

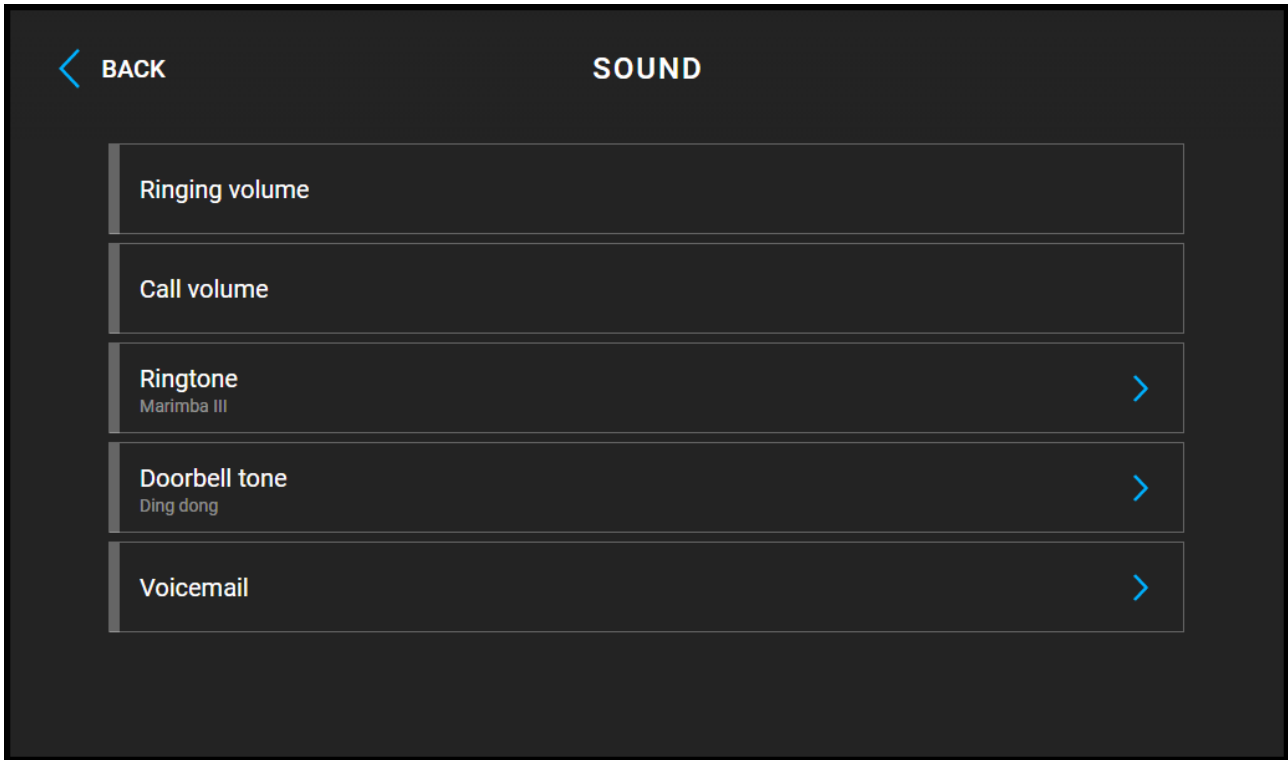

**Ringtone Volume** – set the incoming call ringtone volume.

**Call Volume** – set the phone call volume.

**Ringtone** – sets the ringtone for incoming calls on the device.

**Doorbell Tone** – set the tone to be played when the doorbell is used.

**Voicemail** – set the Voicemail modes directly on the device. This function helps leave a message to be played to the caller if the device fails to answer their incoming call. The caller can record a message to be stored in the device Voicemail and played back on the device later. This settings is particularly useful in working or personal environments where it is important to keep communication even if the user is absent.

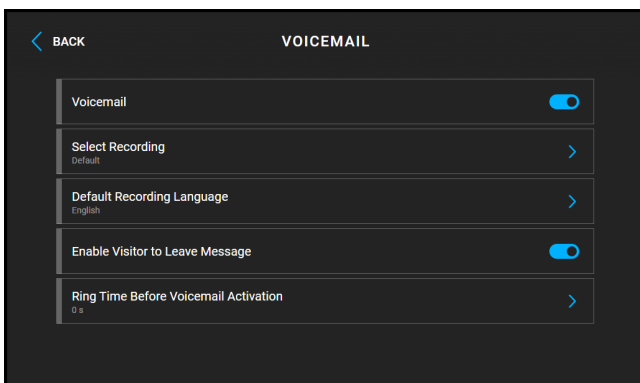

- **Select Recording** – set the Away message to be played to the calling user. You can record a new message through a microphone in this setting.
- **Default Recording Language** – set the language for the default recording.

- **Enable Leaving Message** – allow the caller to leave a message to be stored in the device. When the Away message has been played, a tone is generated and recording starts for up to 20 s. The message includes both audio and video depending on the capacities of the calling device. End the call to terminate the recording earlier. If this function is disabled, the out-of-office message is only played and the call is ended afterwards.
- **Voicemail Activation Timeout** – set the incoming call ringing timeout after which the Away message is played.

## Date and Time

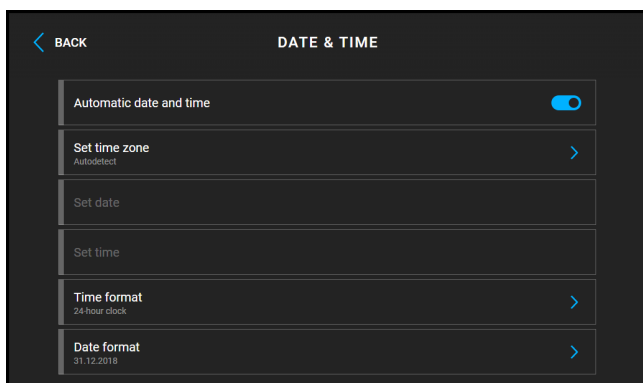

**Automatic date and time** – activates a mode in which the date and time will be taken from the network.

**Set Time Zone** – set the time zone for your installation site to define time shifts and summer/winter time transitions.

**Set date** – used to set the date manually.

**Set time** – used to set time manually.

**Time Format** – set the time format to be displayed.

**Date Format** – set the date format to be displayed.

## Language

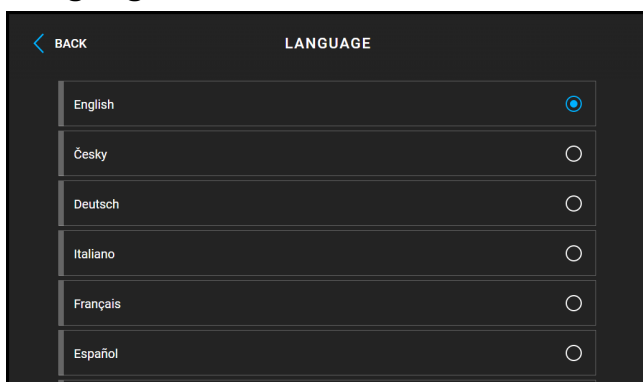

**Language** – set the language for the texts to be displayed. Choose one of the eight pre-defined languages.

**Custom Language** – set the language for the texts to be displayed from an uploaded language file of the user localization.

## Do Not Disturb Mode

**Do Not Disturb Mode** – switch the Do Not Disturb mode on/off. This allows you to switch off the incoming call ringtone while this mode is active. By default, the DND mode does not apply to doorbell notifications, i.e. the incoming ringtone is off and the doorbell ringtone is on. Change this setting via the device web configuration interface in **Calling > Call Configuration > DND Mode for Doorbell Button**.

**Reject Calls in DND Mode** – with this function activated, the device rejects calls in the Do Not Disturb mode. The function can be used for immediate call forwarding at absence to a mobile phone call, for example.

**Mute Doorbell in DND Mode** – with this function activated, the device does not ring when the doorbell button is pressed in the DND mode.

## Weather

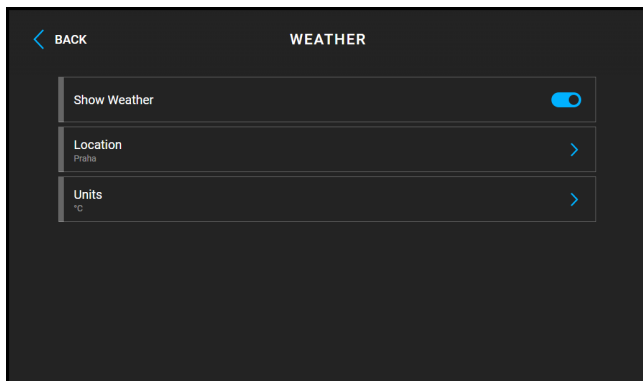

**Display weather** – displays or hides information about the current weather on the home screen.

**Location** – set the device location for weather forecast. Press the Home page weather area shortly to set the location in the Weather / Settings section, which will be displayed automatically. Use the keypad to enter the location name with diacritic marks. Prague is the default location value.

**Units** – allows you to set display in metric (°C) or imperial (°F) units.

## Advanced Settings

Advanced settings are accessible without a code by default. After changing the default password for the web configuration interface, you have to enter a code for access. Set the code for accessing advanced settings in the web configuration interface (**Customization > Display > Hardware > Enable Access to Advanced Settings**).

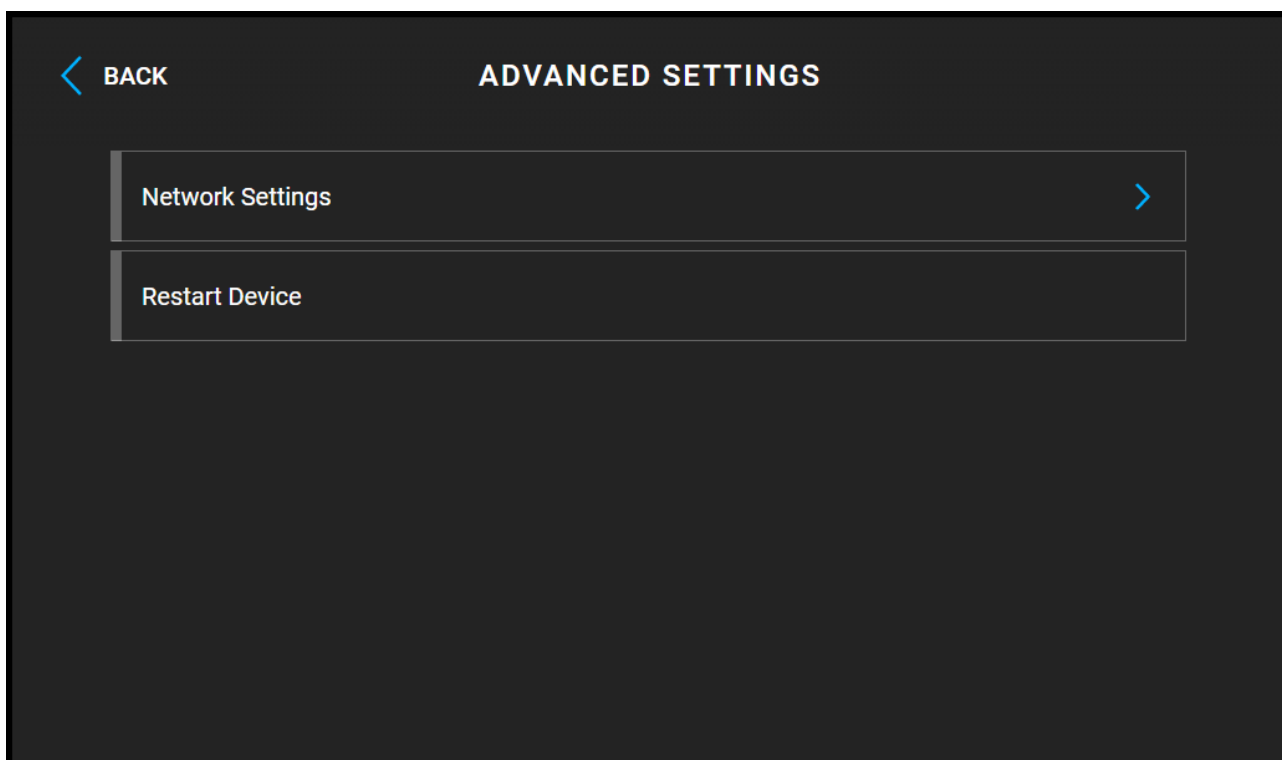

## Network Settings



### NOTE

You can also make network settings in the web configuration interface in **System > Network Connection**.

### General

- **Use DHCP Server** – enable automatic obtaining of the IP address from the LAN DHCP server. If the DHCP server is unavailable or otherwise inaccessible in your LAN, use the manual network settings.
- **Static IP Address setting** – set the static IP address, network mask and default gateway. The parameters are used if the Use DHCP Server parameter is disabled.
- **Required Port Mode** – set the LAN port mode to be preferred (Automatic or Half Duplex – 10 Mbps). The bit rate is reduced to 10 Mbps in case the available LAN cabling is unreliable for a 100 Mbps traffic.
- **Advertised modes** – select the modes to be advertised in auto-negotiation.

### Connection Type

A change of the network interface will not be applied until the device is restarted.

- **Ethernet** – switch the network interface to the Ethernet cable connection.
- **Wi-Fi** – switch the network interface to the Wi-Fi connection.
- **Find Wireless Network** – select any of the available Wi-Fi networks if the Wi-Fi network interface is activated. If a secured Wi-Fi network is selected, the password entering request will appear.

### Restart Device

The process takes about 30 s. Once restart is completed and the device is assigned its IP address, the login window is displayed automatically.

### About

This section provides basic information on the device (serial number, MAC address, FVW version, IP address etc.).

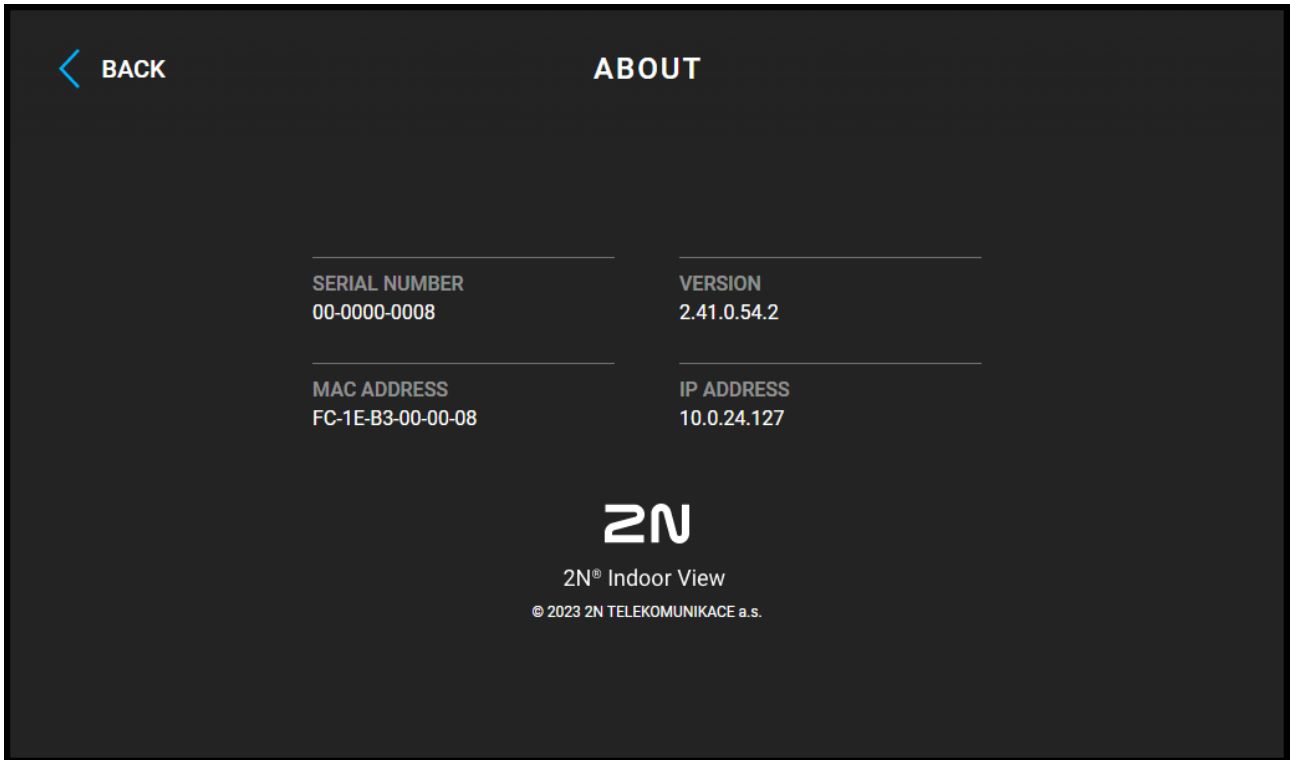

## Control Center



### NOTE

The Control Center is not available in the Hotel mode.

The Control Center provides quick access to selected device functions and HTTP API command sending. Access the Control Center from the Home page by swiping from left to right.

The Control Center component parameters and their location are set in the old version of the web configuration interface, under **Services > Control Center**.

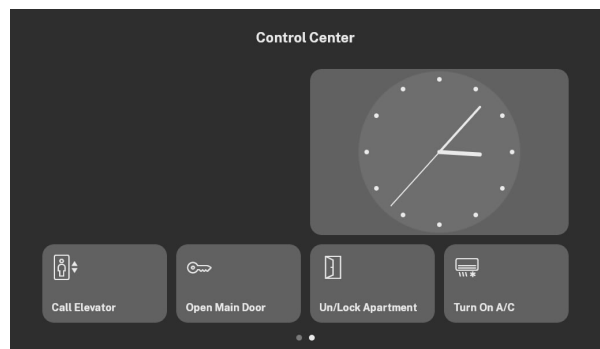

## Hotel Mode

In the Hotel mode, the device can dial calls to one preset contact and receive incoming calls. The device displays time and weather. The other functions are limited. The Do Not Disturb mode cannot be set from the device. The device does not allow access to the Directory, Call Log and Settings menus. The device does not provide quick access to the weather settings. The device does not display notifications (missed calls, door contact states, etc.).

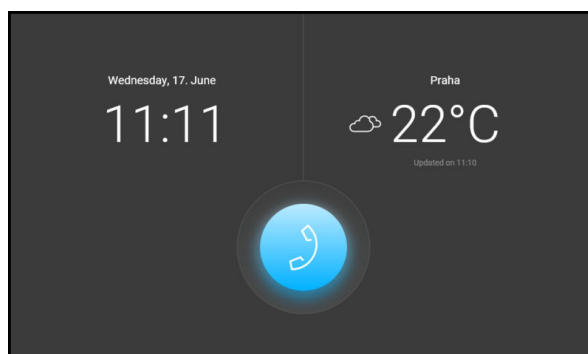













The Hotel mode switches into the Idle mode after the preset timeout passes.



### NOTE

Activate the Hotel mode in the web configuration interface (**Customization > Display > Settings > Device Mode**).

Possible actions	Performance	Action result
Send the set HTTP command	Press the set HTTP command icon	The HTTP command is sent to an external device.
Outgoing call setup		A call to the preset contact is started. Specify the contact in the web configuration interface. Enable the <b>Call After Short Press in Hotel Mode</b> for the contact in the Directory.
Incoming call receiving	 or touch of the display beyond the other icons	Connection with the other device has been established, a call is in progress.
Ringtone Disable		The ringtone stops playing when a call comes in. The incoming call is not ended.
End of Call		The outgoing call is cancelled./The incoming call is rejected./The active call is interrupted.







Possible actions	Performance	Action result
Target device lock opening  (in an active call)		<p>A specifically configured unlock code is sent to the target device and, if the code is compatible with the device, the target device lock opens. If no unlock code is set, the default unlock code is sent to the target device.</p> <p>Door unlocking is signaled by a tone and green flash of the lock button.</p>
<div style="border: 1px solid gray; padding: 10px; background-color: #f0f0f0;">  <p><b>NOTE</b> If no unlocking code is set in the device and no default unlock code is set, the lock button is not displayed.</p> </div>		
Mute call  (in an active call)		<p><b>2N Indoor View Wi-Fi</b> does not transmit audio to the called device.</p> <p>The microphone icons turns red.</p> <p>“Noone can hear you” is displayed in the active call.</p>
Call volume control		The call volume is increased/decreased by one level by each press of +/- or a scale shift.
Called Device Camera Pre-view Switch	 (Cannot be displayed until  is selected.)	The camera preview is switched to another camera assigned to the device. The icon number indicates the camera placement in the sequence.
Camera Pre-view Focus on Face	(Cannot be displayed until  is selected.)	The camera preview focuses on the face of the person standing at the device.
Screenshots		The screenshot is saved in the call log detail. Up to 5 screenshots can be added to one record.

## Operational Statuses

This section includes a basic description of user scenarios and states that can occur during the use of **2N Indoor View Wi-Fi**, a list of user options in variable states and expected results of these actions.

### Signaling of Operational Statuses

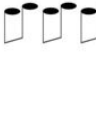
The device generates sounds to signal changes of and switching between operational statuses. Each status change is assigned a different type of tone. See the table below for the list of signals.

Sound signaling	State
	<p><b>Internal application started</b></p> <p>The internal application is launched after the power supply is turned on or the device is restarted.</p>
	<p><b>Connected to the LAN, IP address received</b></p> <p>Once the internal application is started, the device logs in to the LAN.</p>
	<p><b>Disconnected from the LAN, IP address lost.</b></p> <p>Disconnected from the LAN, IP address lost</p>
	<p><b>Invalid phone number or invalid switch activation code</b></p> <p>The device allows you to enter the door opening code. This tone signals that invalid values have been entered.</p>
	<p><b>Reset of network parameters</b></p> <p>Upon power up, the network parameters can be changed by hardware, refer to <a href="#">Brief Guidelines (p. 17)</a>.</p>
	<p><b>Approaching call end signaling</b></p> <p>The device allows you to set a call end timeout, <b>Calling &gt; General settings &gt; Call time limit</b>.</p>
	<p><b>Call extension confirmation signaling</b></p> <p>A call can be extended by pressing a key on the VoIP phone.</p>

Sound signaling	State
-----------------	-------



**Connected call from a VoIP phone to the device**

A short tone is played to signal that the VoIP call has been connected to the device.

**Calls**

In this state, connection or connection attempt is in progress with another device. The **2N Indoor View Wi-Fi** functions are limited, it is impossible to switch to the home page and go to menus. Possible actions are included in the table below.

A preview of the camera if available is shown on the display.

In this state, one of the following call types can be active in the device:

- **Outgoing call** initiated by the **2N Indoor View Wi-Fi** answering unit.
- **Incoming** trying to establish connection with the **2N Indoor View Wi-Fi** answering unit.
- **Active call** – if connection between the devices is established, sound is transmitted and camera preview if available is displayed.

**Outgoing Call**

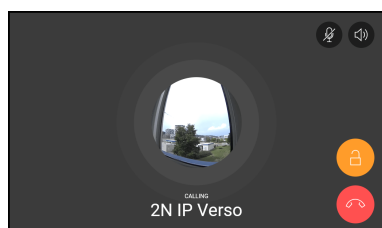







**Incoming Call**







**Active Call**



Possible actions	Performance	Action result
Incoming call receiving	 or touch of the display beyond the other icons	Connection with the other device has been established, a call is in progress.
End of Call		The outgoing call is cancelled./The incoming call is rejected./The active call is interrupted.  <a href="#">Home screen (p. 49)</a> is displayed.

Possible actions	Performance	Action result
Target device lock opening		<p>A specifically configured unlock code is sent to the target device and, if the code is compatible with the device, the target device lock opens. If no unlock code is set, the default unlock code is sent to the target device.</p> <p>Door unlocking is signaled by a tone and green flash of the lock button.</p> <div style="border: 1px solid gray; padding: 10px; margin-top: 20px;"> <p> <b>NOTE</b> If no unlocking code is set in the device and no default unlock code is set, the lock button is not displayed.</p> </div>
Mute call		<p><b>2N Indoor View Wi-Fi</b> does not transmit audio to the called device.</p> <p>The microphone icons turns red.</p> <p>“Noone can hear you” is displayed in the active call.</p> <p>The microphone buttons is flashing yellow.</p> <p>The action reperformance cancels muting.</p>
Call volume control		<p>The call volume is increased/decreased by one level by each press of +/- or a scale shift.</p>
Ringtone Disable		<p>The ringtone stops playing. The incoming call is not ended.</p>

Possible actions	Performance	Action result
Called Device Camera Preview Switch	 (Cannot be displayed until  is selected.)	The camera preview is switched to another camera assigned to the device. The icon number indicates the camera placement in the sequence.
Camera Preview Focus on Face	(Cannot be displayed until  is selected.)	The camera preview focuses on the face of the person standing at the device.
Screenshots		The screenshot is saved in the call log detail. Up to 5 screenshots can be added to one record.
HTTP command sending in call.	Press the set HTTP command icon	The HTTP command is sent to an external device.

## Idle Mode

**2N Indoor View Wi-Fi** transits into the Idle mode after a set inactivity period. You can determine the length of this period in **Customization > Backlight** in the web configuration. The operation power consumption is reduced in the Idle mode.

The device can show the following in the Idle mode as configured:

- door contact state,
- current weather information,
- date,
- time.

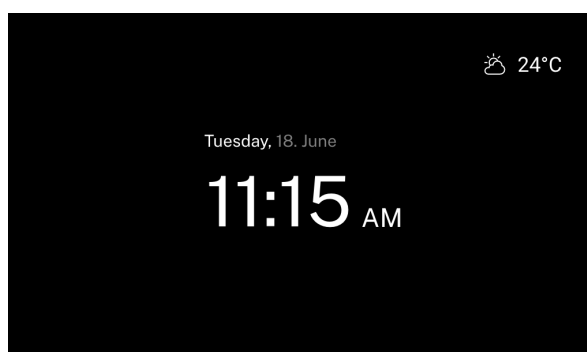

Possible actions	Performance	Action result
Idle mode end	Touch any spot on the display.	The device quits the Idle mode. The <a href="#">Directory Menu (p. 50)</a> , <a href="#">Home Screen (p. 49)</a> or <a href="#">Device Lock (Screen Lock) (p. 65)</a> is displayed.

## Device Lock (Screen Lock)

When the **2N Indoor View Wi-Fi** lock is activated, enter the PIN code for device locking. The same PIN code is required for device unlocking.

When the lock is activated, the device rings to signal an incoming call and displays the caller identification including the camera preview if available. The call cannot be received until the device lock is deactivated.

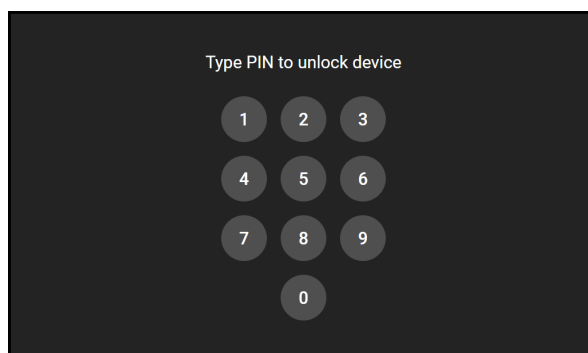

Possible actions	Performance	Action result
Device lock activation	Activation of the function and setting of a 4-digit PIN code with subsequent confirmation	The lock is activated.
Device lock deactivation	Correct PIN entering	<p>The device is unlocked and you can go to other operational statuses and perform other actions.</p> <p>When an incorrect PIN code is entered, a remedy instruction is displayed. The count of incorrect PIN code entering attempts is unlimited.</p>

## Do Not Disturb Mode

The incoming call ringtone is switched off in the DND mode. A call can be received, rejected or ended, see [Calls](#) (p. 62).

The display shows the camera preview if available, CLIP and the *Incoming call* message.

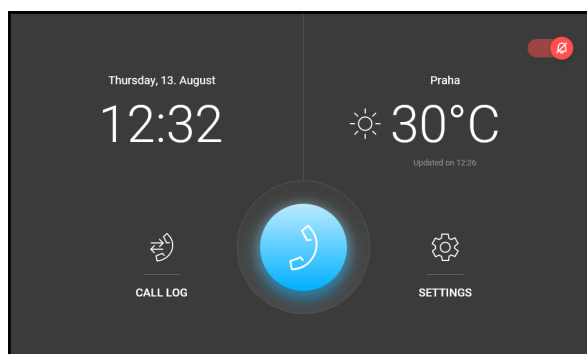



### CAUTION

The doorbell tone is switched on. Set the doorbell tone in the DND mode in the web interface ([Calls](#) > [Calls](#) > [Incoming calls](#) > [Do Not Disturb mode for doorbell](#)).

In the DND mode, you can also set automatic call rejection for the device (directly on the device or in [Calls](#) > [General settings](#) > [Incoming calls](#) > [Reject calls in DND mode](#)) and automatic DND activation/deactivation according to the set time profiles ([Calls](#) > [Calls](#) > [Incoming calls](#) > [Do Not Disturb mode with time profile](#)).

With the hotel mode on, it is not possible to switch the device into the DND mode and the DND icon is hidden on the home screen.

Possible actions	Performance	Action result
Do Not Disturb Activation	 on the home screen or in the Settings menu.	Activation of the Do Not Disturb mode. The DND mode can be disabled by a repeated short press of  .
Do Not Disturb Deactivation	 on the home screen or in the Settings menu.	DND is deactivated and the doorbell icon turns white.

## Maintenance - Cleaning

**2N Indoor View Wi-Fi** contains no environmentally harmful components. Dispose of the device in accordance with the applicable legal regulations.

If used frequently, the device surface gets dirty. Use a piece of soft cloth moistened with clean water to clean the device. Use appropriate cleaning agents suitable for glasses, optical devices, screens, etc. We recommend that IT cleaning wipes are used.



### **CAUTION**

Use the product for the purposes it was designed and manufactured for, in compliance herewith. The manufacturer reserves the right to modify the product in order to improve its qualities.

If used frequently, the device surface gets dirty. Use a piece of soft cloth moistened with clean water to clean the device. Use appropriate cleaning agents suitable for glasses, optical devices, screens, etc. We recommend that IT cleaning wipes are used.

- Alcohol-based cleaners may not be applied.
- Do not use aggressive detergents (such as abrasives or strong disinfectants).
- Clean the device in dry weather in order to make waste water evaporate quickly.

# Troubleshooting

Refer to <https://www.2n.com/faqs> for the most frequently solved problems.

# Technical Parameters

## 2N Indoor View Wi-Fi

Supply type	Consumption	Polarity reversal protection	Power Consumption in idle
PoE, IEEE 802.3af (recommended)	12 W	✓	2.9 W
12 V DC ±10 % adapter; 1 A	12 W	✓	2.9 W

User interface	
Controls	capacitive touch panel
Display	7" with 1024 × 600 pixel resolution

Signaling protocol	
SIP	UDP, TCP, TLS

Audio	
Microphone	integrated
Speaker	2 W integrated
Induction loop output	600 mV RMS

## Technical Parameters

### Audio stream

Protocols	RTP, RTSP
Codecs	G.711, G.729, G.722, L16/16kHz

### Video stream

Protocols	RTP, RTSP, HTTP
Codecs	H.264
Video Resolution	1280 x 720 px

### Interface

LAN	10/100BaseT, RJ-45; Cat5e or higher
Wi-Fi	2.4/5GHz 802.11a/b/g/n/ac
2 wires 10 Mbit	2N 2 wire-IP 10 Mbit, recommended single core 24AWG, cat3 cable

### Doorbell input

Input type	Switching contact (button/relay)
Contact type	Normally open (NO)

Contact parameters

Max. 50 V / 5 mA, DC

## Technical Parameters

### Mechanical Parameters

---

Device dimensions (W x H x D)	193 × 157 × 50 mm
-------------------------------	-------------------

---

Weight	Main unit	555 g
--------	-----------	-------

---

Operating temperature	0 to 50 °C
-----------------------	------------

---

Relative humidity	10 to 90 % non-condensing
-------------------	---------------------------

---

Storing temperature	-20 °C to 70 °C
---------------------	-----------------

---

Recommended altitude	up to 2000 m
----------------------	--------------

---

## General Instructions and Cautions

Please read this User Manual carefully before using the product and follow the instructions and recommendations included therein.

Any use of the product that is in contradiction with the instructions provided herein may result in malfunction, damage or destruction of the product.

The manufacturer shall not be liable and responsible for any damage incurred as a result of a use of the product other than that included herein, namely undue application and disobedience of the recommendations and warnings.

Any use or connection of the product other than those included herein shall be considered undue and the manufacturer shall not be liable for any consequences arisen as a result of such misconduct.

Moreover, the manufacturer shall not be liable for any damage or destruction of the product incurred as a result of misplacement, incompetent installation and/or undue operation and use of the product in contradiction herewith.

The manufacturer assumes no responsibility for any malfunction, damage or destruction of the product caused by incompetent replacement of parts or due to the use of reproduction parts or components.

The manufacturer shall not be liable and responsible for any loss or damage incurred as a result of a natural disaster or any other unfavorable natural condition.

The manufacturer shall not be held liable for any damage of the product arising during the shipping thereof.

The manufacturer shall not make any warrant with regard to data loss or damage.

The manufacturer shall not be liable and responsible for any direct or indirect damage incurred as a result of a use of the product in contradiction herewith or a failure of the product due to a use in contradiction herewith.

All applicable legal regulations concerning the product installation and use as well as provisions of technical standards on electric installations have to be obeyed. The manufacturer shall not be liable and responsible for damage or destruction of the product or damage incurred by the consumer in case the product is used and handled contrary to the said regulations and provisions.

The consumer shall, at its own expense, procure software protection of the product. The manufacturer shall not be held liable for any damage incurred as a result of the use of deficient security software.

The consumer shall, without delay, change the access password for the product after installation. The manufacturer shall not be held liable or responsible for any damage incurred in connection with the use of the original password.

The manufacturer also assumes no responsibility for additional costs incurred by the consumer as a result of making calls to increased tariff lines.

### **Directives, Laws and Regulations**

**2N Indoor View Wi-Fi** conforms to the following directives and regulations:

#### **EU**

## Industry Canada

This Class B digital apparatus complies with Canadian ICES-003/NMB-003.

## Legislation of Japan

本製品は、特定無線設備の技術基準適合証明を受けています。

この装置は、クラス A 機器です。この装置を住宅環境で使用すると電波妨害を引き起こすことがあります。この場合には使用者が適切な対策を講ずるよう要求されることがあります。VCCI-A

本製品は、シールドネットワークケーブル(STP)を使用して接続してください。また適切に接地してください。

本製品は電気通信事業者（移動通信会社、固定通信会社、インターネットプロバイダ等）の通信回線（公衆無線 LAN を含む）に直接接続することができません。本製品をインターネットに接続する場合は、必ずルータ等を経由し接続してください。

## Electric Waste and Used Battery Pack Handling



Do not place used electric devices and battery packs into municipal waste containers. An undue disposal thereof might impair the environment!

Deliver your expired household electric appliances and battery packs removed from them to dedicated dumpsites or containers or give them back to the dealer or manufacturer for environmental-friendly disposal. The dealer or manufacturer shall take the product back free of charge and without requiring another purchase. Make sure that the devices to be disposed of are complete.

Do not throw battery packs into fire. Battery packs may not be taken into parts or short-circuited either.



2N Indoor View Wi-Fi – User Manual

© 2N Telekomunikace a. s., 2026

**2N.com**